

Water Specialist WS2H and WS3 Control Valve Programming and Wiring Manual

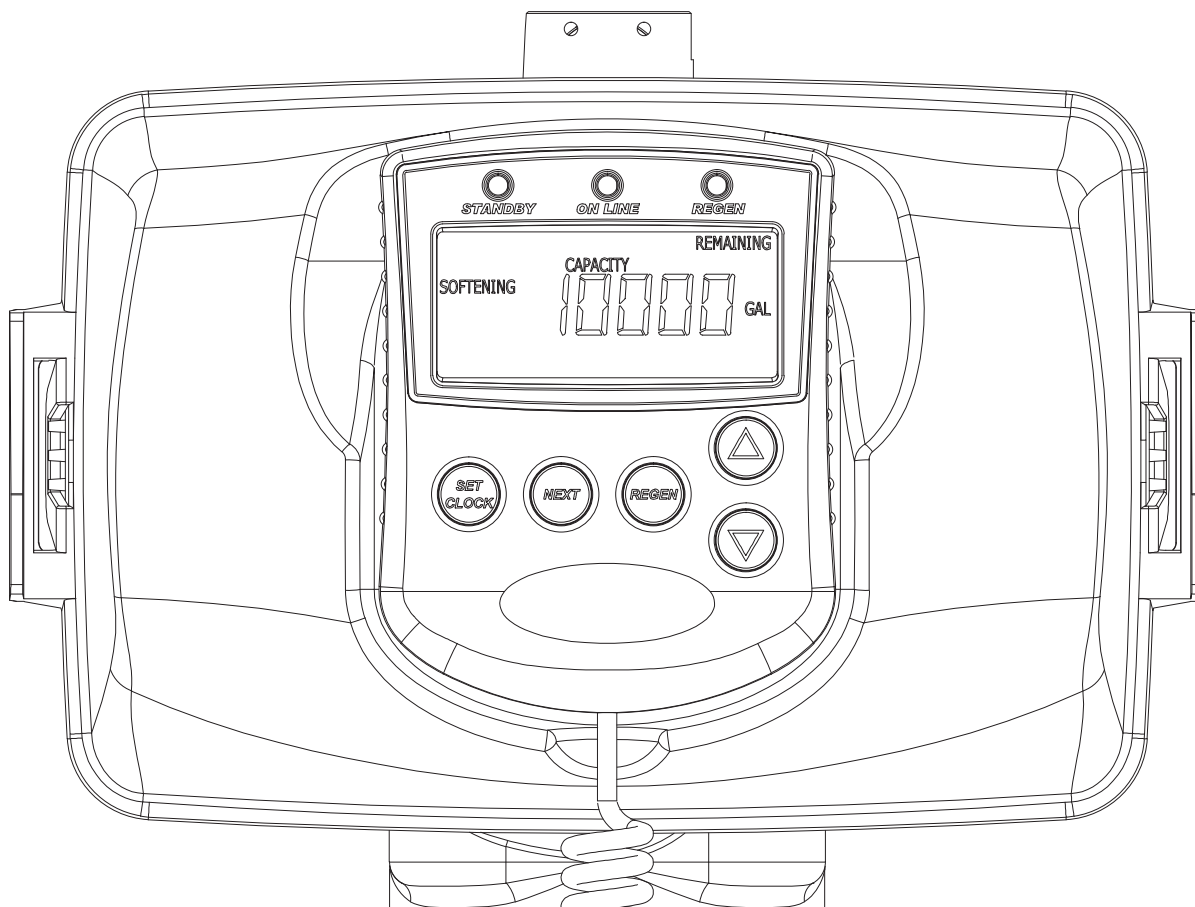

Table of Contents

General Information 4
Software and Power Supply Compatibility 5
Wiring for Custom AC Adapter and Custom Meter Wiring 6
PC Board layout 7
Optional System PC Board Relay 1 and 2, and Separate Source drive connections 9
Motorized Drive Operations 9
Wiring and System Configuration Guides 10
Quick Reference Programming Screens 20
User Screens..... 22
Setting Time of Day 23
System Setup Screens 24
Cycle Setup Screens..... 27
Timer Screens 29
Installer Setup Screens 31
Diagnostic Screens..... 32
Valve History 34

Table 1
General Specifications and Pre-Installation Checklist

Minimum/Maximum Operating Pressures	20 psi (138 kPa) -125 psi (862 kPa)	
Minimum/Maximum Operating Temperatures	40°F (4°C) – 110°F (43°C)	
Power Adapter:	<u>U.S.</u>	<u>International</u>
Supply Voltage	120V AC	230V AC
Supply Frequency	60 Hz	50 Hz
Output Voltage	20V or 24V AC see Table 2	20V or 24V AC
Output Current	800 mA	800 mA
No user serviceable parts are on the PC board, the motor, or the Power adapter. The means of disconnection from the main power supply is by unplugging the Power adapter from the wall.		
Service flow rate	WS2H Valve: 125 gpm (473 lpm, 28.4 m ³ /h) @ 15 psig (103 kPa) drop WS3 Valve: 250 gpm (946 lpm, 56.8 m ³ /h) @ 15 psig (103 kPa) drop	
Backwash flow rate	WS2H Valve: 125 gpm (473 lpm, 28.4 m ³ /h) @ 25 psig (172 kPa) drop WS3 Valve: 220 gpm (833 lpm, 50.0 m ³ /h) @ 25 psig (172 kPa) drop	
CV Service	WS2H Valve: 32.3 WS3 Valve: 64.6	
CV Backwash	WS2H Valve: 25.0 WS3 Valve: 44.0	
Meter:	WS2H Valve: Internal Meter	WS3 Valve: Optional External Meter
Accuracy	± 5 %	± 5 %
Flow Range	1.5 – 125 gpm (5.7 – 473 lpm)	3.5 – 350 gpm (13.3 – 1325 lpm)
Regenerant Refill Rate	WS2H and WS3 Valves: Variable - Shipped from Factory with 2.2 gpm (8.33 lpm)	
Injectors	WS2H & WS3 Valves: See Injector Graphs V3010-2A through 2H	
Brine Line Adapters Included	1" Male NPT Elbow & ¾" x 1" Solvent Weld Elbow	
Inlet, Outlet and Drain Line Openings	WS2H Valve: 2" Female NPT or BSPT or 2.5" Groove Lock WS3 Valve: 3" Female NPT or BSPT, No Groove Lock	
Distributor Tube Opening:	Female NPT Inlet & Outlet	Female BSPT Inlet & Outlet
WS2H Valve	2.375" OD (2.0" NPS)	63 mm OD
WS3 Valve	3.5" OD (3" NPS)	90 mm OD
Tank Connection:	4"-8UN, 6" Flange, Side Mount (2" Female NPT or BSPT or 2.5" Groove Lock)	
WS2H Valve	6" Flange or Side Mount (3" Female NPT or BSPT)	
WS3 Valve		
Shipping Weight	WS2H Valve with Meter: 50 lbs (22.7 kg) WS3 Valve: 57 lbs (25.9 kg) Meter Sold Separately	
PC Board Memory	Nonvolatile EEPROM (electrically erasable programmable read only memory)	
Compatible with the following typical concentrations of regenerants/chemicals	Sodium chloride, potassium chloride, potassium permanganate, sodium bisulfite, chlorine and chloramines	



Table 2
Software and Power Supply Compatibility









Software Version		Power Supply			
V3242-01BOARD Main Board ¹	V3243-01BOARD System Board	Output Voltage	Part # and Description		
114.10	1.03	24 VAC	V3461 ² WS2H/3 AC ADAPTER V3461EU WS2H/3 AC ADAPTER EU V3461UK WS2H/3 AC ADAPTER UK		
114.11					
115.17	1.07 or 1.08				
115.25					
200.01					
215.02	1.11 or 1.13				
215.03					
215.04					
215.10	1.11 or 1.13			24 VAC	V3461 ² WS2H/3 AC ADAPTER V3461EU WS2H/3 AC ADAPTER EU V3461UK WS2H/3 AC ADAPTER UK
				20 VAC ³	V3461-01 WS2H/3 AC ADAPTER 20V V3461EU-01 WS2H/3 AC ADAPTER EU 20V V3461UK-01 WS2H/3 AC ADAPTER UK 20V

¹It is recommended to maintain one version throughout a system.

²Replacement V3461 power supplies have screw terminals and are shipped less a cord. Use cord from existing power supply to connect to the screw terminals.

³V3461EU-01 and V3461UK-01 will not be available for sale until August 2010.

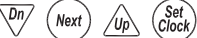
- 
STANDBY
 Standby LED
 Used to signal a unit not in service or regeneration. LED will flash 1/sec. If flow is detected while off line or 2/sec. If the bypass manual override switch is forcing the bypass online.
 - 
ON LINE
 On Line LED
 Used to signal a unit currently in service. LED will flash 2/sec. If the bypass manual override switch is forcing the bypass online.
 - 
REGEN
 Regen LED
 Used to signal a unit currently in regen.
- All LED's are off while in any programming mode

- 
Set Clock
 Set clock from any USER field. Exit & save from setup or program screens.
- 
Next
 Move to the next display
- 
Up **Dn**
 Change variable being displayed
- 
Regen
 Toggles scheduled regen time on/off. Holding for >3 sec. starts immediate regen (immediate regen is the only option if set to immediately regenerate upon 0 gallons). Moves back one display while in program mode.
- 
Next **Regen**
 Reset
 Holding for >3 seconds initiates a reset. The software version is shown and the piston returns to the "home" position, re-synchronizing the valve.
- 
Set Clock **Regen**
 History Reset
 Holding the Set Clock & Regen buttons for >3 seconds initiates a totalizer or history reset.
- 
Dn **Next** **Up** **Set Clock**
 Key sequence to lock and unlock software.
- 
Set Clock **Regen**
 Medium Reset
 From User 1 Screen - Volume Remaining
 Press and hold the Set Clock and Regen buttons for 10 seconds to reset valve to factory default programming. History and Diagnostics are not changed.

Recommended System Setup Sequence:

1. Connect all wiring and communication cables.
2. Apply power.
3. Enter system setup screens and set screen 2 to number of units in the particular system.
 - a. Setting this valve assigns master status to that unit.
 - b. The master unit will establish communication with the remaining units and transfer the remaining settings to them.
4. Set cycle sequence.
5. Set cycle times.
6. Set installer data.

Wiring for custom AC Adapter

1. See Table 2 Software and Power Supply Compatibility.
2. Cable should be one unshielded pair of 22AWG, UV resistant UL2464 compliant wire.
3. Connector details:
 - a. Terminate end with one Molex white housing, P/N 09-50-8043 and four Molex pins, P/N 08-50-0108.
 - b. Pin 1 = AC from power supply (White)
 Pin 2 = Jumper to Pin 3
 Pin 3 = Jumper to Pin 2
 Pin 4 = AV from power supply (Black)

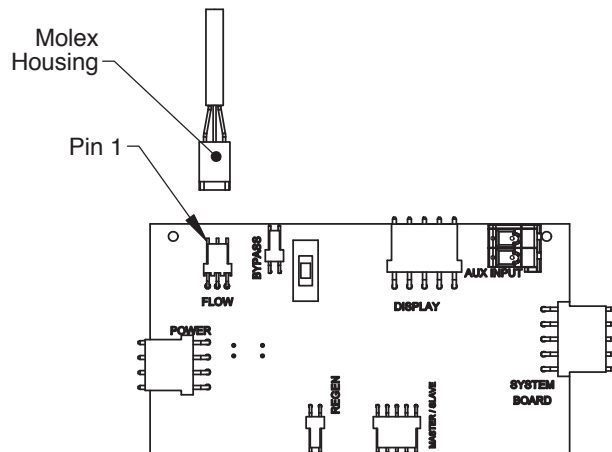
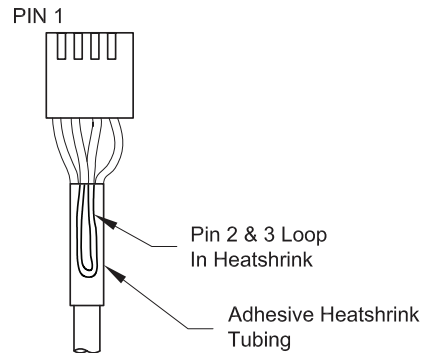

Custom Meter Wiring:

- 1) Terminate end with a Molex series 2695 housing, part number 22-01-3037 and (3) Molex series 41572 (or 40445) pins, part number 08-65-0805 (or 97-00-44).
- 2) Auxilliary meter must be able to operate on 5VDC,
 Pin 1 = +5VDC,
 Pin 2 (Center) = Signal
 Pin 3 = Ground
- 3) Acceptable pulse input is .1 – 999 pulses/gallon, or .4 – 519 pulses / liter.

Main PC Board with System Board

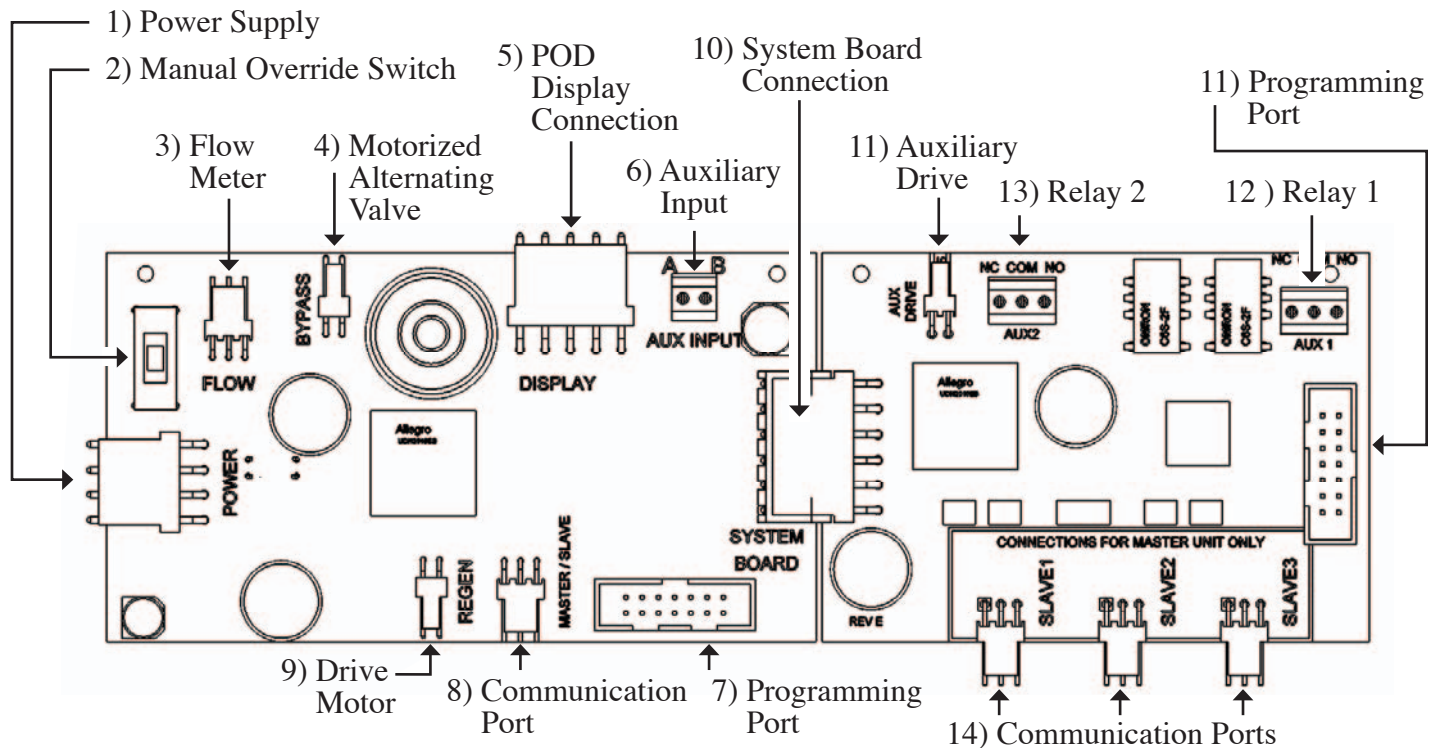

- 1) Unit's main power supply. Labeled POWER.
- 2) Isolation valve manual override switch will force the unit on-line or off-line. The corresponding LED indicator on the display POD will flash rapidly, 2 times per second, to warn that the unit is in a forced state.
- 3) Flow meter input. Labeled FLOW.
- 4) Drive circuit for Motorized Alternating Valve (MAV) or for a Motorized Bypass valve (V3060). It will bring a unit on-line or off-line based on the programming of the current system. Labeled BYPASS.
- 5) POD connection for the display. This connection is also used as the data extraction port with the proper software and cabling.
- 6) Auxiliary Input to control/ trigger when or how a unit can regenerate based on the setting of the dP screen in the programming setup. External inputs should be dry contacts and units wired in parallel require matching each unit's polarity. Labeled AUX INPUT.
- 7) Programming port connection for Main PC Board is for factory use only.
- 8) Main board communication port can be used as the communication port for a 2 unit master and is the communication port for every slave unit of a system. Labeled MASTER/ SLAVE.
- 9) Drive Motor circuit power the motor that drives the piston during regeneration. Labeled REGEN.
- 10) Connection for Optional System Board. This board would be added to units requiring the extra drive circuit to operate a separate source valve, if a 2, 3, or 4 unit progressive flow/ alternator system was needed, or when relays would need to operate external devices. Labeled SYSTEM BOARD.
- 11) Auxiliary Drive circuit is used to operate a Motorized Alternating Valve (MAV) based on the program setting of the separate source inlet on or off. This drive circuit is timed to sequence after a unit is isolated from a system, or prior to regen for units with no isolation. Labeled AUX DRIVE.
- 12) Dry contact outputs to operate external devices based on the program setting of Relay 1. Labeled AUX 1.
- 13) Dry contact outputs to operate external devices based on the program setting of Relay 2. Labeled AUX 2.
- 14) Additional communication ports used on the master control valve for systems with 3 or 4 units. See wiring diagrams for examples. Labeled SLAVE 1, SLAVE 2, and SLAVE 3.

Communication Cable Connection to PC Board Layout

Revised communication cable connectivity.

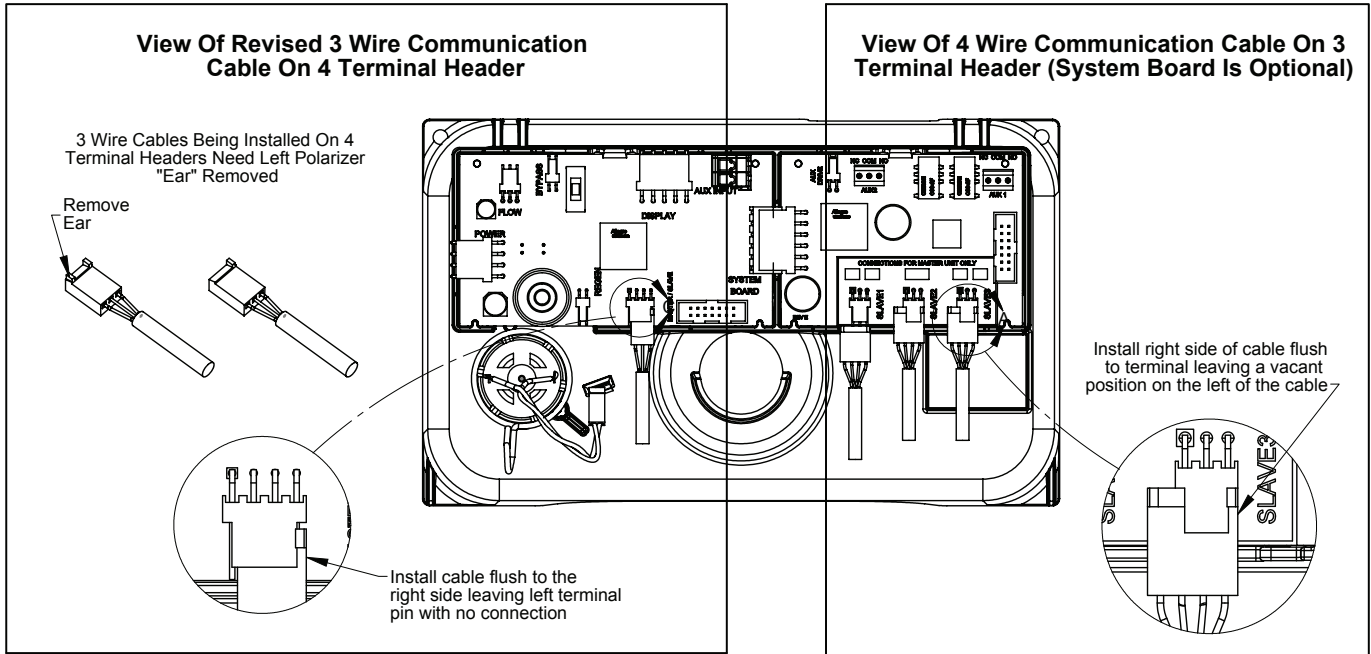

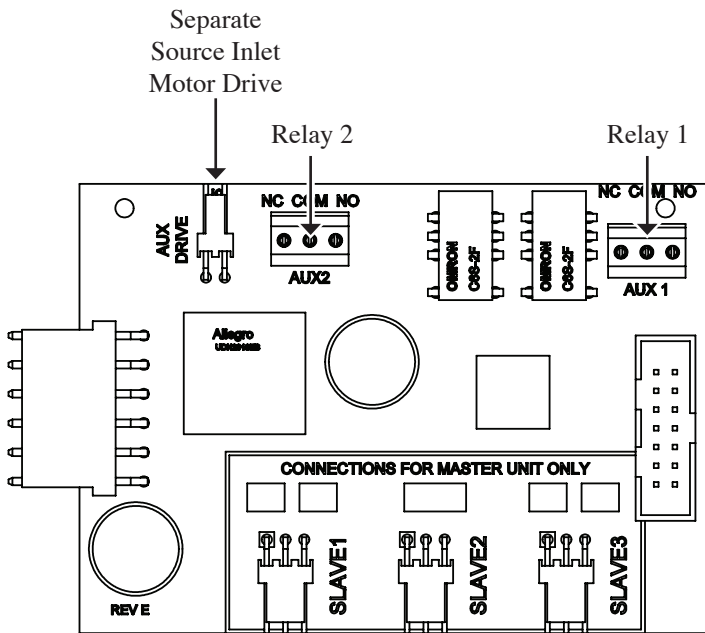

Optional System Board, Required For Relay Output And Separate Source Inlet

- 1) Relay outputs 1 & 2 have N.O., N.C. and common dry contacts.
- 2) Maximum power through relays to be:
 - a. 1A, 30 VDC
 - b. 1A, 30 VAC
- 3) Separate source inlet drives require connection to a V3063 or V3063BSPT, V3076 or V3076BSPT motorized alternating valve (MAV).

Motorized Drive Operation

Viewing the piston rod through the clear dome is a visual indicator of the drive's current position. On the WS2 motorized bypass drive, viewing the rod indicates that the unit is in service. Viewing the rod as shown on the MAV indicates that the common port is currently connected to the "B" port. If the rod is not visible the unit is offline in the case of a bypass, or the common port is currently connected to the "A" port of a MAV. In this state the "B" port of a MAV is shut off. This drive logic is reversible to meet specific plumbing applications by reversing the polarity of the drive motor wiring harness as shown below.

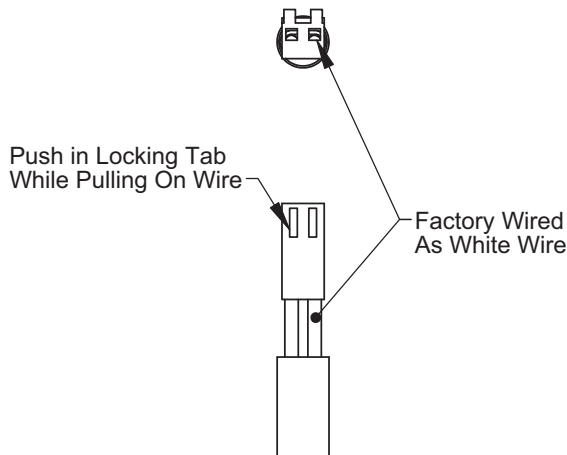
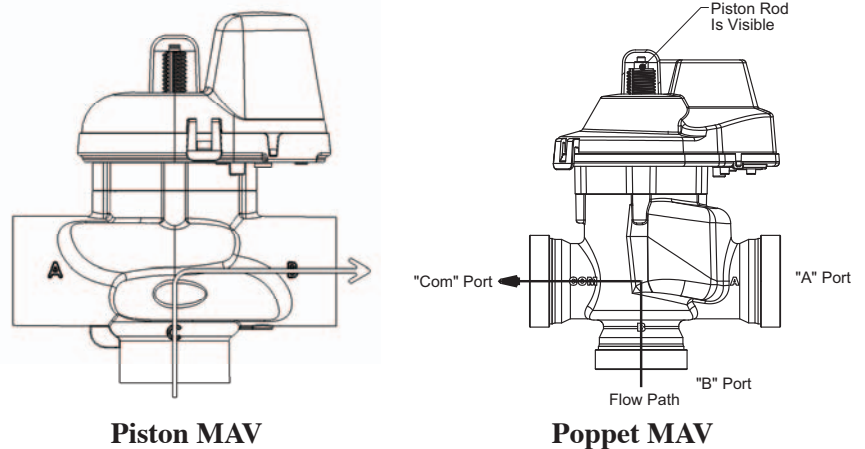

Reversing Motorized Drive Direction

WS2 motorized bypass and MAV drives are factory wired with the white wire on the right when viewing the wiring harness as shown, reversing the wires reverses the logic of the drive. The wires can be removed from the housing by holding down the locking tab in the small window while applying light pressure to the wire, being careful not to disengage the wire from its crimped on connector. The wires can then be re-inserted, being sure the locking tab re-engages in the window.

WS2H Single Unit System Operations

Single tank system with a MAV valve for No Hard Water Bypass

- MAV valve will need to be installed on the control valve's outlet port
- Port "B" or "C" of the MAV valve needs to be connected to the control valve's outlet port
- Port "A" of the MAV valve needs to be plugged off
- The MAV valve's motor wire needs to be connected to the two pin connection labeled "BYPASS" on the control valve's PC Board
- System Board required to operate available Relay Outputs
- System Board provides (2) Relay Outputs with N.O. , COM , and N.C. SPST dry contacts

Piston Style

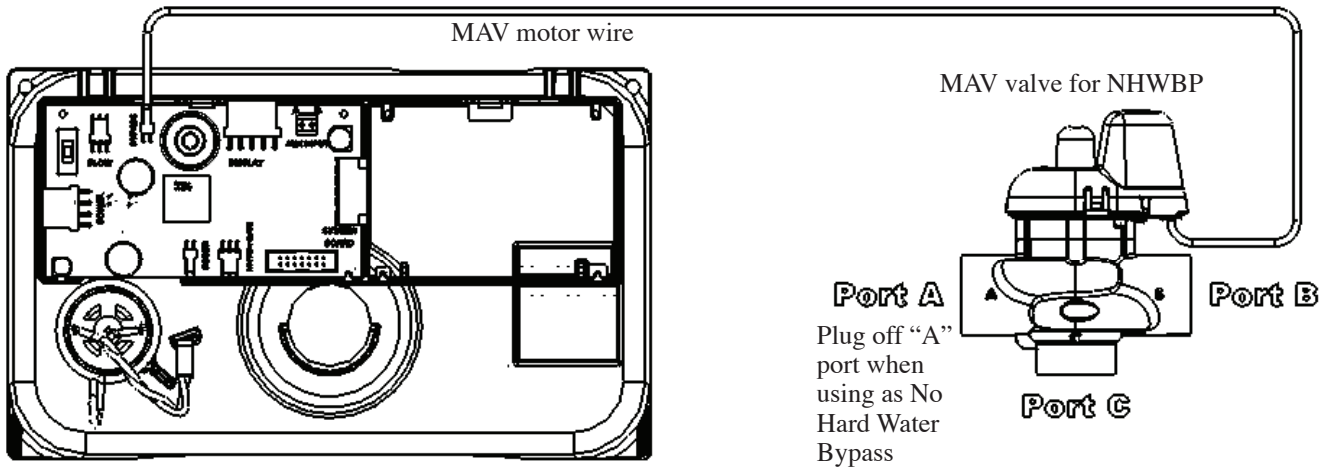

Poppet Style

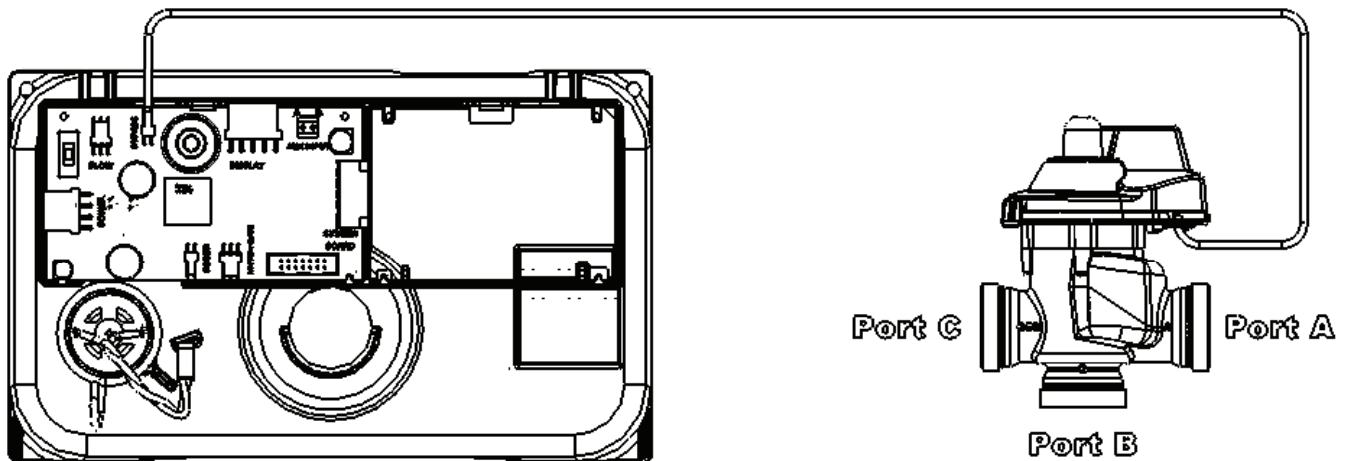

Single tank system with System Board and MAV valve for Separate Source with a secondary MAV valve for No Hard Water Bypass

- System Board required to operate Separate Source MAV valve
- The MAV valve for Separate Source needs to be installed on the control valve’s inlet port
- Port “C” of the MAV valve for Separate Source needs to be connected to the control valve’s inlet port
- Port “B” of the MAV valve for Separate Source will become the raw water inlet to the control valve
- Port “A” of the MAV valve for Separate Source will become the Separate Source inlet feed to the control valve
- The MAV valve’s motor wire for Separate Source needs to be connected to the two pin connection on the System Board labeled “AUX DRIVE”
- The MAV valve for No Hard Water Bypass will need to be installed on the control valve’s outlet port
- Port “B” or “C” of the MAV valve for No Hard Water Bypass needs to be connected to the control valve’s outlet port
- Port “A” of the MAV valve for No Hard Water Bypass needs to be plugged off
- The MAV valve’s motor wire needs to be connected to the two pin connection labeled “BYPASS” on the control valves PC Board

Single tank system with System Board for Relay Outputs

- System Board required to operate available Relay Outputs
- System Board provides (2) Relay Outputs with N.O. , COM , and N.C. SPST dry contacts

Piston Style

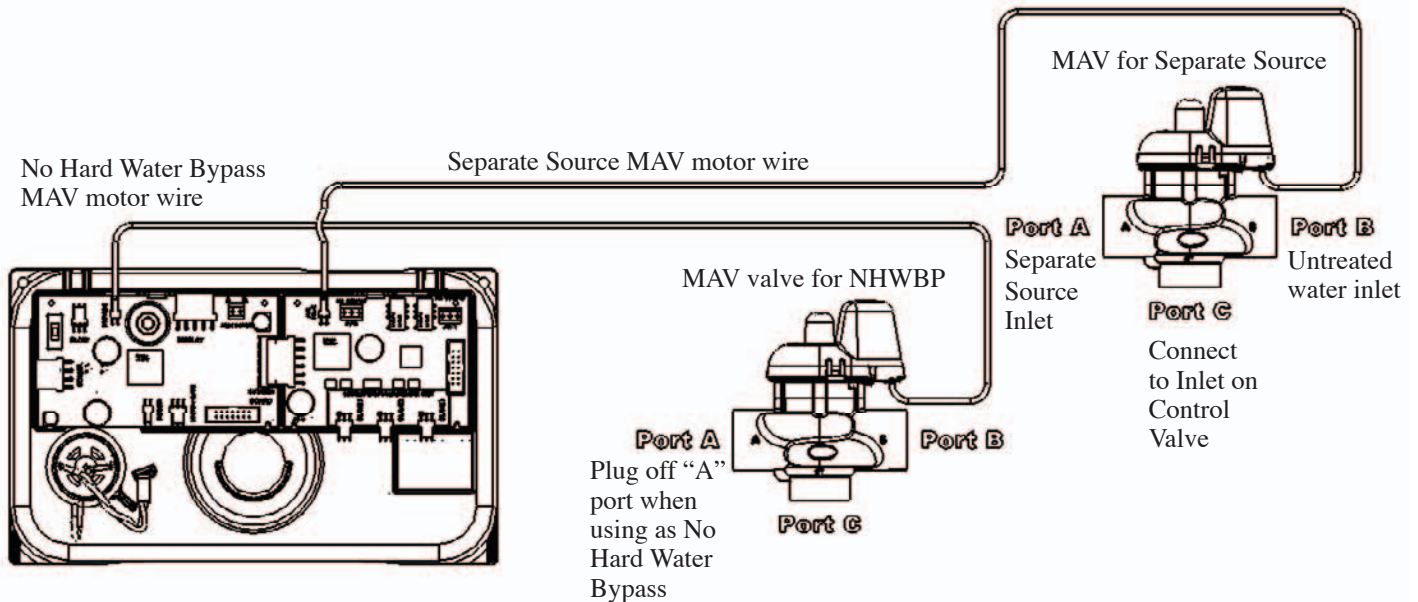

Poppet Style

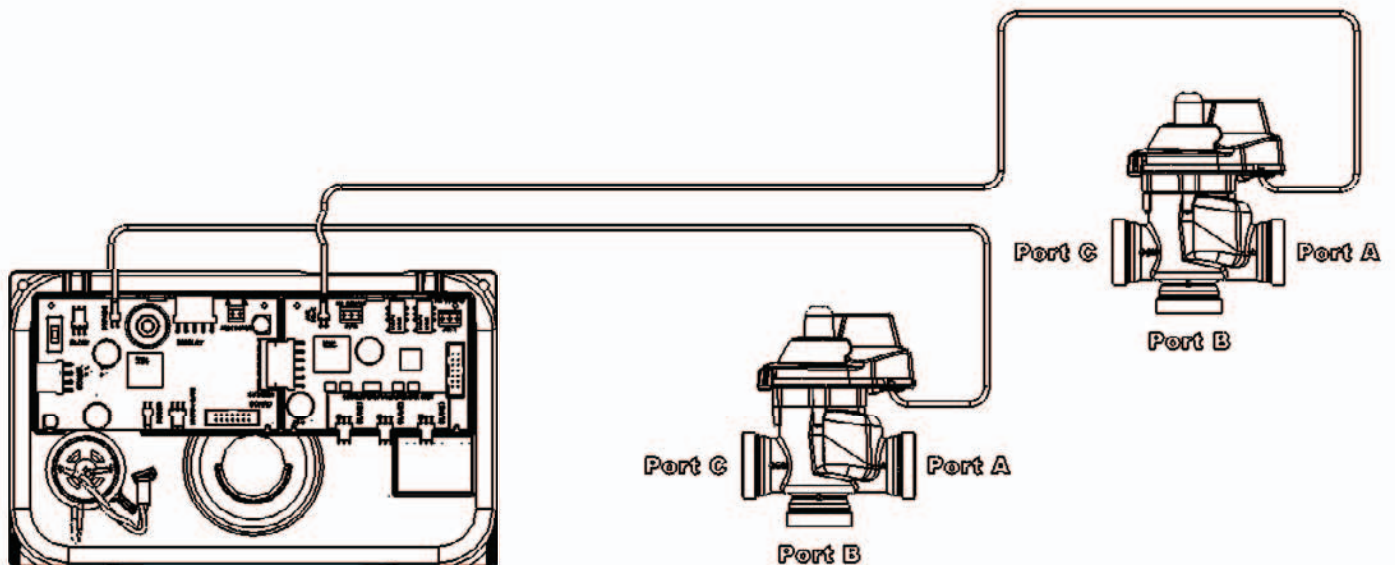

WS2H Two Unit System Operations

Two tank system, Simple Alternator with (1) MAV valve

- (1) MAV valve and (1) communication cable is required for a Simple Alternator
- The MAV valve's motor wire needs to be connected to the two pin connection labeled "BYPASS" on Unit 2's PC Board
- The communication cable needs to be connected to Unit 1's three pin connection labeled "MASTER/SLAVE" and Unit 2's three pin connection labeled "MASTER/SLAVE"
- To regenerate with raw/ untreated water the outlet port of Unit 1 needs to be piped to Port "A" of the MAV valve, the outlet port of Unit 2 needs to be piped to Port "B" of the MAV valve, and Port "C" or common will be the common outlet for Unit 1 & Unit 2
- To regenerate with soft/ treated water the MAV valve needs to be installed on the main inlet feed line to Unit 1 & Unit 2, Port "C" of the MAV valve will become the new common inlet for both Unit 1 & Unit 2. Port "A" of the MAV valve will need to be piped to the inlet port of Unit 1, and Port "B" of the MAV valve will need to be piped to the inlet port of Unit 2
- As a Alternator only, the unit in Stand-By will perform a Pre-Service downflow rinse to drain before coming on-line
- If a single external meter is to be used, the wire connection for that meter needs to be connected to Unit 2's PC Board three pin connection labeled "FLOW." Also when a single external meter is to be used, in System Setup Screens under system setup 10 "System Pulses" needs to be selected and then the proper meter pulses for the external meter needs to be set in the next screen.
- System Board required to operate available Relay Outputs
- System Board provides (2) Relay Outputs with N.O. , COM , and N.C. SPST dry contacts

Piston Style

Unit 1/Alt A

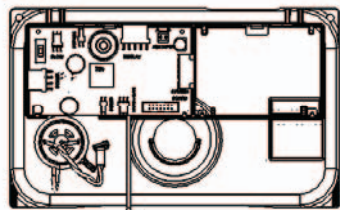

Communication Cable

Unit 2

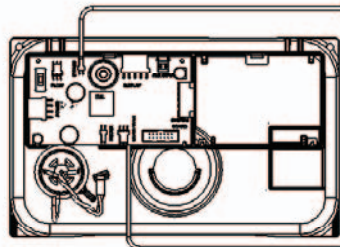

MAV motor wire
MAV for twin alternating



Connect to outlet of control valve set for ALT A

Common outlet

Connect to outlet of control valve deemed as ALT b

Poppet Style

Unit 1/Alt A

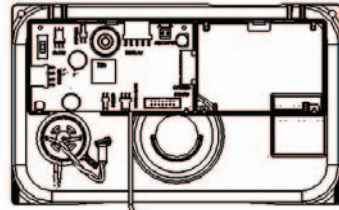

Unit 2

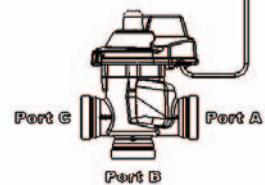
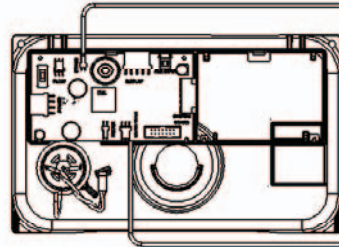

Two tank system, Alternator and/or Progressive Flow with a MAV valve on each for No Hard Water Bypass

- (2) MAV valves and (1) communication cable are required
- The communication cable needs to be connected to Unit 1’s three pin connection labeled “MASTER/SLAVE” and Unit 2’s three pin connection labeled “MASTER/SLAVE”
- Each MAV valve’s motor wire will need to be connected to the two pin connection on the PC Board labeled “BYPASS” for each control valve
- Each MAV valve will need to be installed on the outlet port of each control valve for No Hard Water Bypass, which allows for raw/ untreated water regeneration for twin alternating and/or progressive flow
- Port “B” or “C” of each MAV valve needs to be connected to the control valve’s outlet port
- Port “A” of each MAV valve needs to be plugged off
- To regenerate with soft/ treated water each MAV valve would need to be installed on the inlet port of each control valve for No Hard Water Bypass. This will allow soft/ treated water from the opposing unit to back feed through the outlet of the unit that requires regeneration for twin alternating and/or progressive flow
- As a Alternator only, the unit in Stand-By will perform a Pre-Service downflow rinse to drain before coming on-line
- System Board required to operate available Relay Outputs
- System Board provides (2) Relay Outputs with N.O. , COM , and N.C. SPST dry contacts

Piston Style

Poppet Style

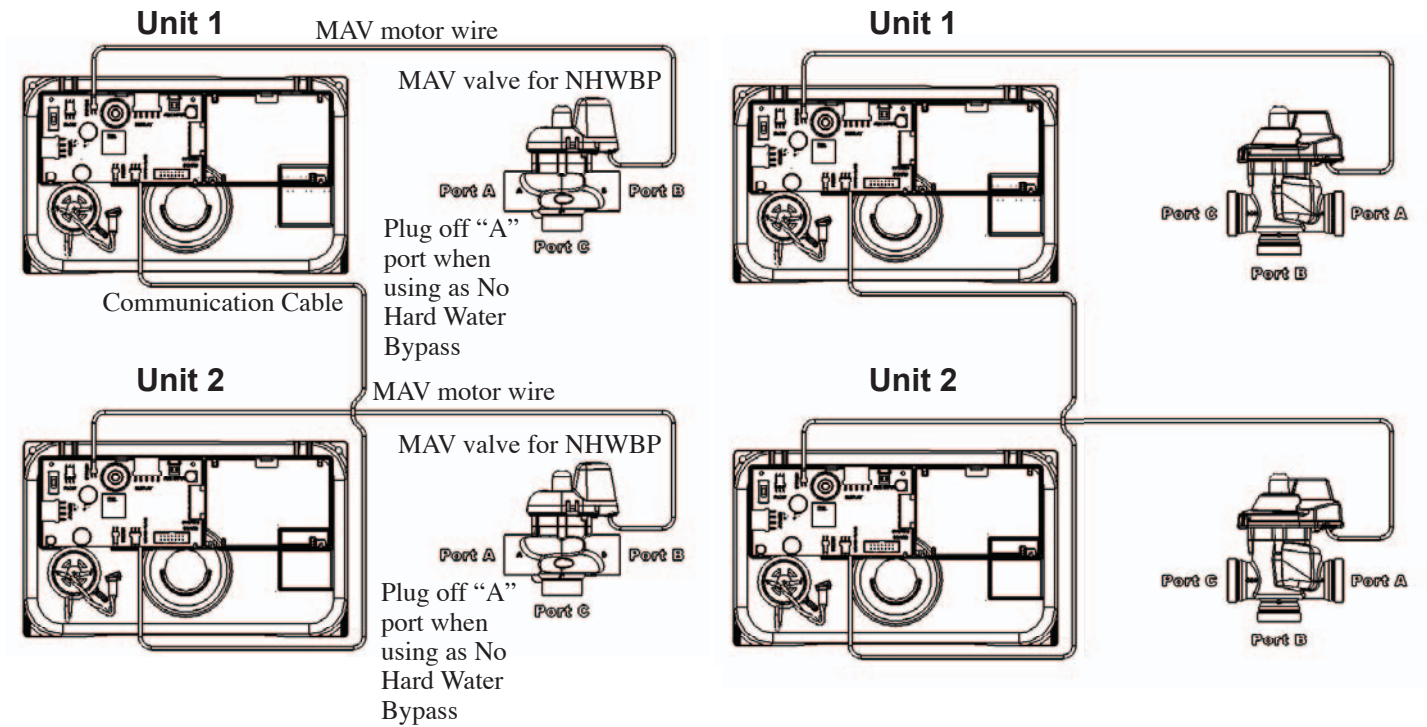

Two tank system, Alternator and/or Progressive Flow with System Boards for Separate Source/ Relay Outputs and (2) MAV valves on each for Separate Source and No Hard Water Bypass

- (2) System Boards are required to operate Separate Source MAV valve and/or Relay Outputs
- (4) MAV valves and (1) communication cable are required
- The communication cable needs to be connected to Unit 1’s three pin connection labeled “MASTER/SLAVE” and Unit 2’s three pin connection labeled “MASTER/SLAVE”
- (2) MAV valves for Separate Source need to be installed on each of the control valve’s inlet ports
- Port “C” of the MAV valves for Separate Source need to be connected to each of the control valve’s inlet ports
- Port “B” of the MAV valves for Separate Source will become the raw water inlets to each of the control valves
- Port “A” of the MAV valves for Separate Source will become the Separate Source inlet feeds to each of the control valves
- Each MAV valve’s motor wire for Separate Source need to be connected to the two pin connections on each of the System Boards labeled “AUX DRIVE”
- The MAV valves for No Hard Water Bypass will need to be installed on each of the control valve’s outlet ports
- Port “B” or “C” of the MAV valves for No Hard Water Bypass need to be connected to each of the control valve’s outlet ports
- Port “A” of the MAV valves for No Hard Water Bypass need to be plugged off
- The MAV valve’s motor wire for No Hard Water Bypass need to be connected to the two pin connection labeled “BYPASS” on each of the control valve’s PC Boards
- As a Alternator only, the unit in Stand-By will perform a Pre-Service downflow rinse to drain before coming on-line
- System Board required to operate available Relay Outputs
- System Board provides (2) Relay Outputs with N.O. , COM , and N.C. SPST dry contacts

Piston Style

Poppet Style

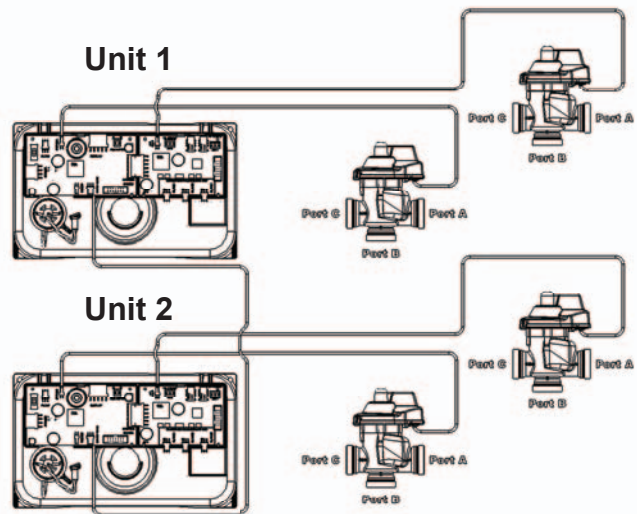
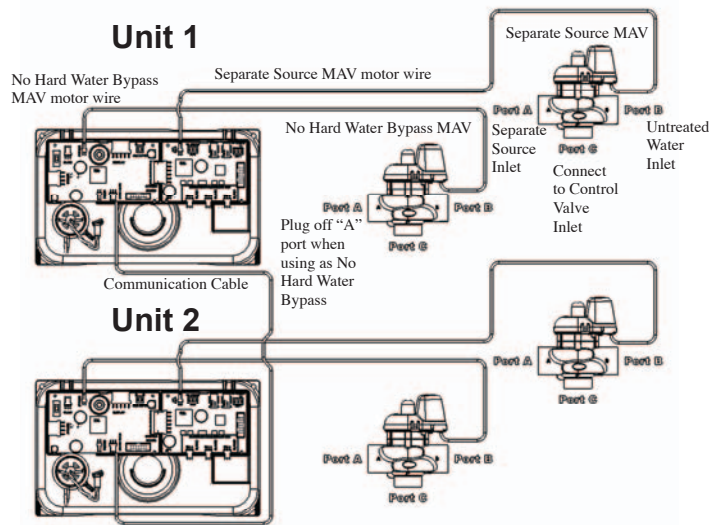

WS2H Three Unit System Operations

- Three tank system, Alternator and/or Progressive Flow with System Board and MAV valve on each for No Hard Water Bypass
- (1) System Board and (2) communication cables required to communicate between 3 units
 - (3) MAV valve's are required
 - (1st) communication cable needs to be connected to Unit 1's System Board three pin connection labeled "SLAVE 1" and Unit 2's three pin connection on the PC Board labeled "MASTER/SLAVE"
 - (2nd) communication cable needs to be connected to Unit 1's System Board three pin connection labeled "SLAVE 2" and Unit 3's three pin connection on the PC Board labeled "MASTER/SLAVE"
 - Each MAV valve's motor wire will need to be connected to the two pin connection on the PC Board labeled "BYPASS" for each control valve
 - Each MAV valve will need to be installed on the outlet port of each control valve for No Hard Water Bypass, which allows for raw/ untreated water regeneration for triplex alternating and/or progressive flow
 - Port "B" or "C" of each MAV valve needs to be connected to each of the control valve's outlet ports
 - Port "A" of each MAV valve needs to be plugged off
 - To regenerate with soft/ treated water each MAV valve would need to be installed the inlet port of each control valve for No Hard Water Bypass. This will allow soft/ treated water from the opposing unit to back feed through the outlet of the unit that requires regeneration for triplex alternating and/or progressive flow
 - As a Alternator only, the unit in Stand-By will perform a Pre-Service downflow rinse to drain before coming on-line
 - System Board required to operate available Relay Outputs
 - System Board provides (2) Relay Outputs with N.O. , COM , and N.C. SPST dry contacts

Piston Style

Poppet Style

Unit 1

Unit 1

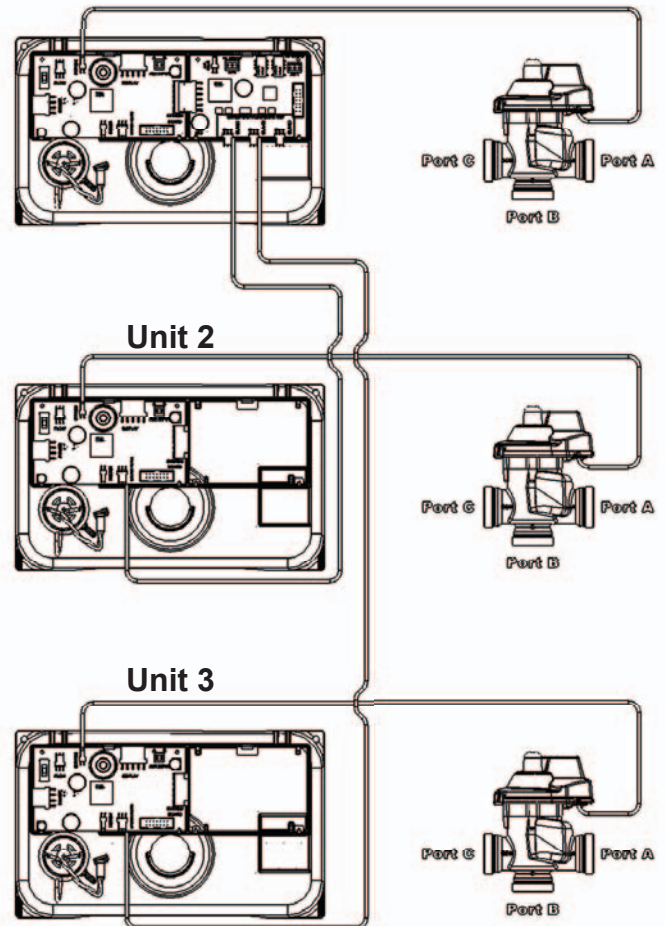
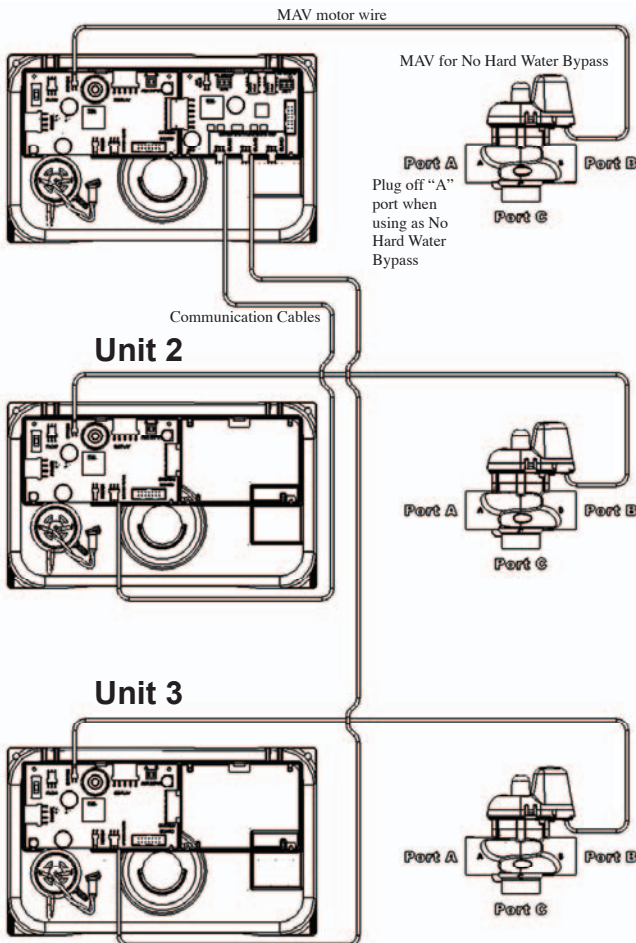

Three tank system, Alternator and/or Progressive Flow with System Boards for Separate Source/ Relay Outputs and (2) MAV valves on each for Separate Source and No Hard Water Bypass

- (3) System Boards are required to communicate 3 units and operate Separate Source MAV valves and/or Relay Outputs
- (6) MAV valves and (2) communication cable are required
- (1st) communication cable needs to be connected to Unit 1's System Board and three pin connection labeled "SLAVE 1" and Unit 2's three pin connection on the PC Board labeled "MASTER/SLAVE"
- (2nd) communication cable needs to be connected to Unit 1's System Board three pin connection labeled "SLAVE 2" and Unit 3's three pin connection on the PC Board labeled "MASTER/SLAVE"
- (3) MAV valves for Separate Source need to be installed on each of the control valve's inlet ports
- Port "C" of the MAV valves for Separate Source need to be connected to each of the control valve's inlet ports
- Port "B" of the MAV valves for Separate Source will become the raw water inlets to each of the control valves
- Port "A" of the MAV valves for Separate Source will become the Separate Source inlet feeds to each of the control valves
- The MAV valve's motor wire for Separate Source need to be connected to the two pin connections on each of the System Boards labeled "AUX DRIVE"
- The (3) MAV valves for No Hard Water Bypass will need to be installed on each of the control valve's outlet ports
- Port "B" or "C" of the MAV valves for No Hard Water Bypass need to be connected to each of the control valve's outlet ports
- Port "A" of the MAV valves for No Hard Water Bypass need to be plugged off
- The MAV valve's motor wire for No Hard Water Bypass need to be connected to the two pin connection labeled "BYPASS" on each of the control valve's PC Boards
- As an Alternator only, the unit in Stand-By will perform a Pre-Service downflow rinse to drain before coming on-line
- System Board required to operate available Relay Outputs
- System Board provides (2) Relay Outputs with N.O. , COM , and N.C. SPST dry contacts

Piston Style

Poppet Style

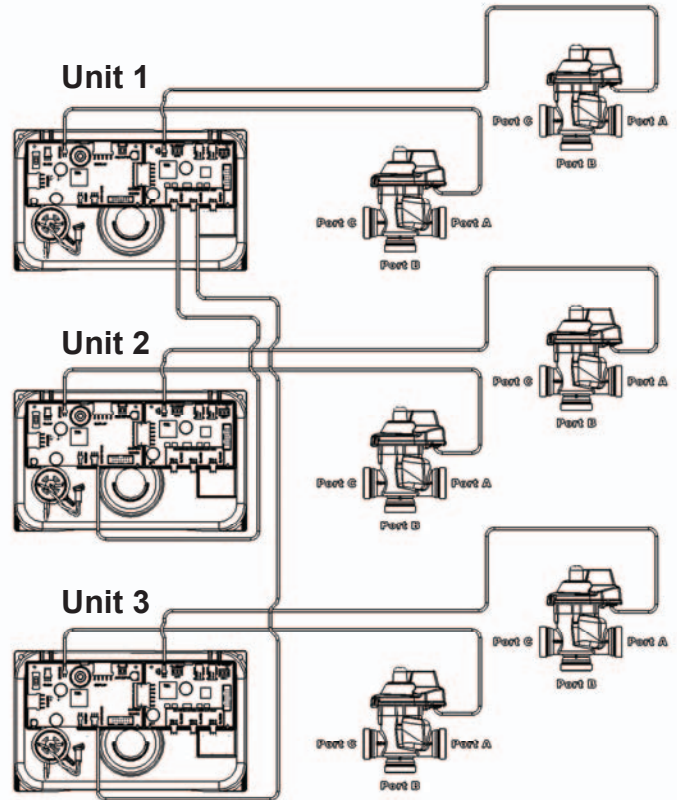
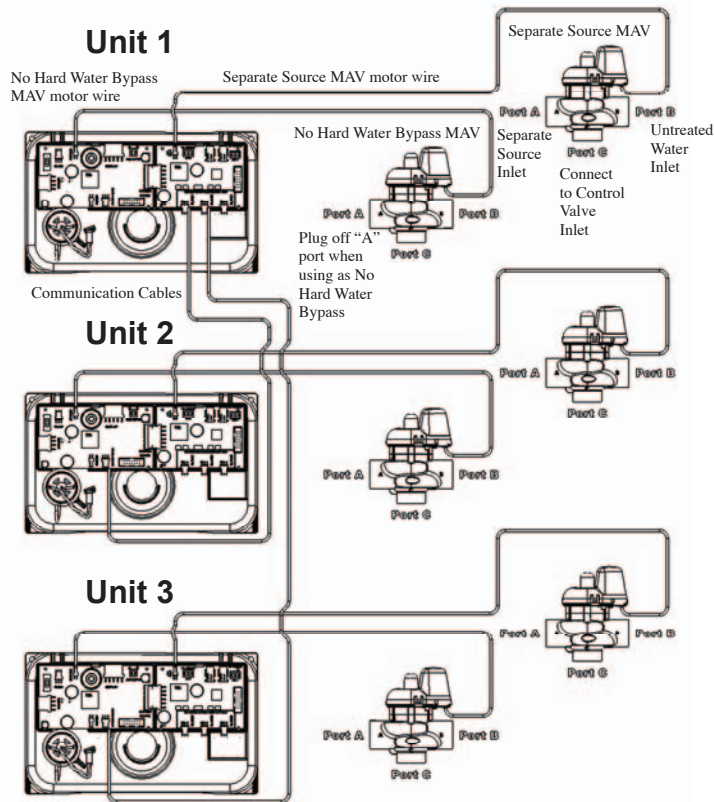

WS2H Four Unit System Operations

- Four tank system, Alternator and/or Progressive Flow with System Board and MAV valve on each for No Hard Water Bypass
- (1) System Board and (3) communication cables required to communicate between 4 units
- (4) MAV valves are required
- (1st) communication cable needs to be connected to Unit 1's System Board three pin connection labeled "SLAVE 1" and Unit 2's three pin connection on the PC Board labeled "MASTER/SLAVE"
- (2nd) communication cable needs to be connected to Unit 1's System Board three pin connection labeled "SLAVE 2" and Unit 3's three pin connection on the PC Board labeled "MASTER/SLAVE"
- (3rd) communication cable needs to be connected to Unit 1's System Board three pin connection labeled "SLAVE 3" and Unit 4's three pin connection on the PC Board labeled "MASTER/SLAVE"
- Each MAV valve's motor wire will need to be connected to the two pin connection on the PC Board labeled "BYPASS" for each control valve
- Each MAV valve will need to be installed on the outlet port of each control valve for No Hard Water Bypass, which allows for raw/ untreated water regeneration for triplex alternating and/or progressive flow
- Port "B" or "C" of each MAV valve needs to be connected to each of the control valve's outlet ports
- Port "A" of each MAV valve needs to be plugged off
- To regenerate with soft/ treated water each MAV valve would need to be installed the inlet port of each control valve for No Hard Water Bypass. This will allow soft/ treated water from the opposing unit to back feed through the outlet of the unit that requires regeneration for triplex alternating and/or progressive flow
- As a Alternator only, the unit in Stand-By will perform a Pre-Service downflow rinse to drain before coming on-line
- System Board required to operate available Relay Outputs
- System Board provides (2) Relay Outputs with N.O. , COM , and N.C. SPST dry contacts

Piston Style

Poppet Style

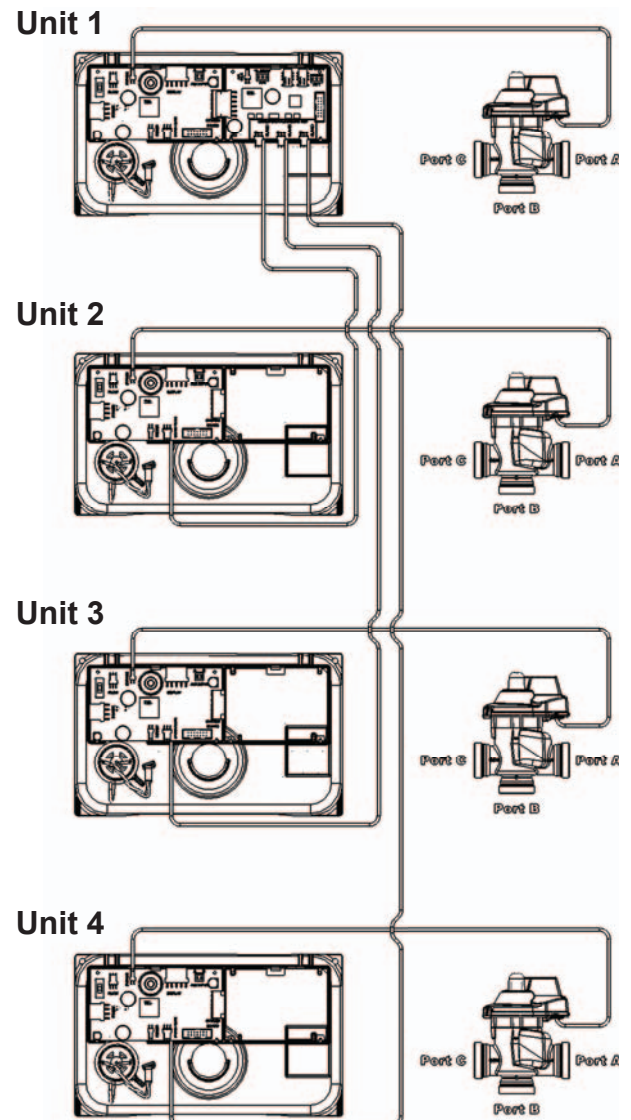
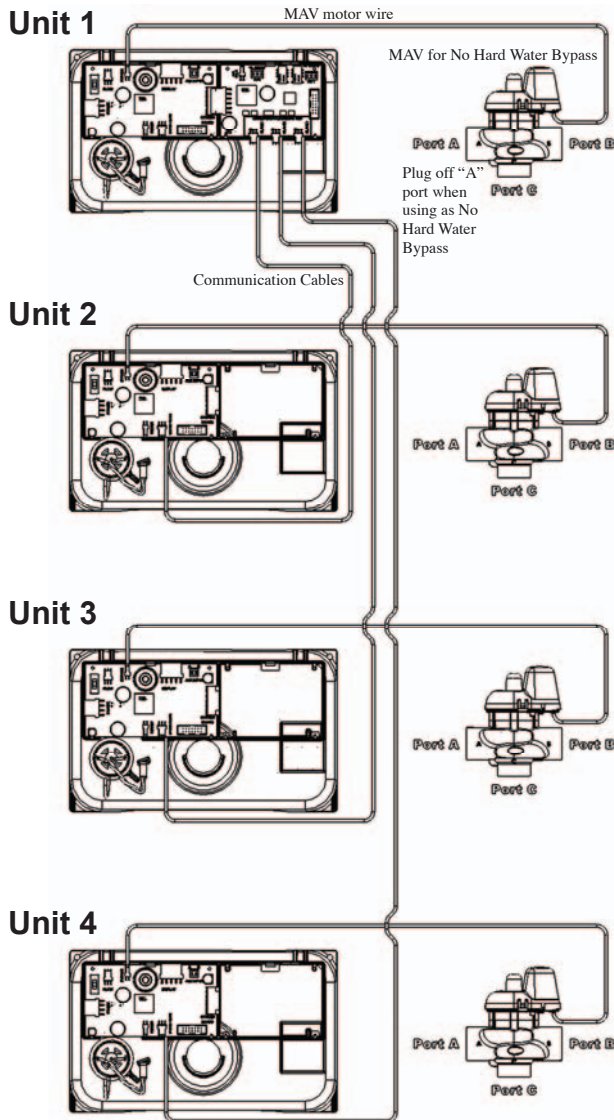

Four tank system, Alternator and/or Progressive Flow with System Boards for Separate Source/ Relay Outputs and (2) MAV valves on each for Separate Source and No Hard Water Bypass

- (4) System Boards are required to communicate 4 units and operate Separate Source MAV valves and/or Relay Outputs
- (8) MAV valves and (3) communication cable are required
- (1st) communication cable needs to be connected to Unit 1's System Board and three pin connection labeled "SLAVE 1" and Unit 2's three pin connection on the PC Board labeled "MASTER/SLAVE"
- (2nd) communication cable needs to be connected to Unit 1's System Board three pin connection labeled "SLAVE 2" and Unit 3's three pin connection on the PC Board labeled "MASTER/SLAVE"
- (3rd) communication cable needs to be connected to Unit 1's System Board three pin connection labeled "SLAVE 3" and Unit 4's three pin connection on the PC Board labeled "MASTER/SLAVE"
- (4) MAV valves for Separate Source need to be installed on each of the control valve's inlet ports
- Port "C" of the MAV valves for Separate Source need to be connected to each of the control valve's inlet ports
- Port "B" of the MAV valves for Separate Source will become the raw water inlets to each of the control valves
- Port "A" of the MAV valves for Separate Source will become the Separate Source inlet feeds to each of the control valves
- Each MAV valve's motor wire for Separate Source need to be connected to the two pin connections on each of the System Boards labeled "AUX DRIVE"
- The (4) MAV valves for No Hard Water Bypass will need to be installed on each of the control valve's outlet ports
- Port "B" or "C" of the MAV valves for No Hard Water Bypass need to be connected to each of the control valve's outlet ports
- Port "A" of the MAV valves for No Hard Water Bypass need to be plugged off
- Each MAV valve's motor wire for No Hard Water Bypass need to be connected to the two pin connection labeled "BYPASS" on each of the control valve's PC Boards
- As a Alternator only, the unit in Stand-By will perform a Pre-Service downflow rinse to drain before coming on-line
- System Board required to operate available Relay Outputs
- System Board provides (2) Relay Outputs with N.O. , COM , and N.C. SPST dry contacts

Piston Style

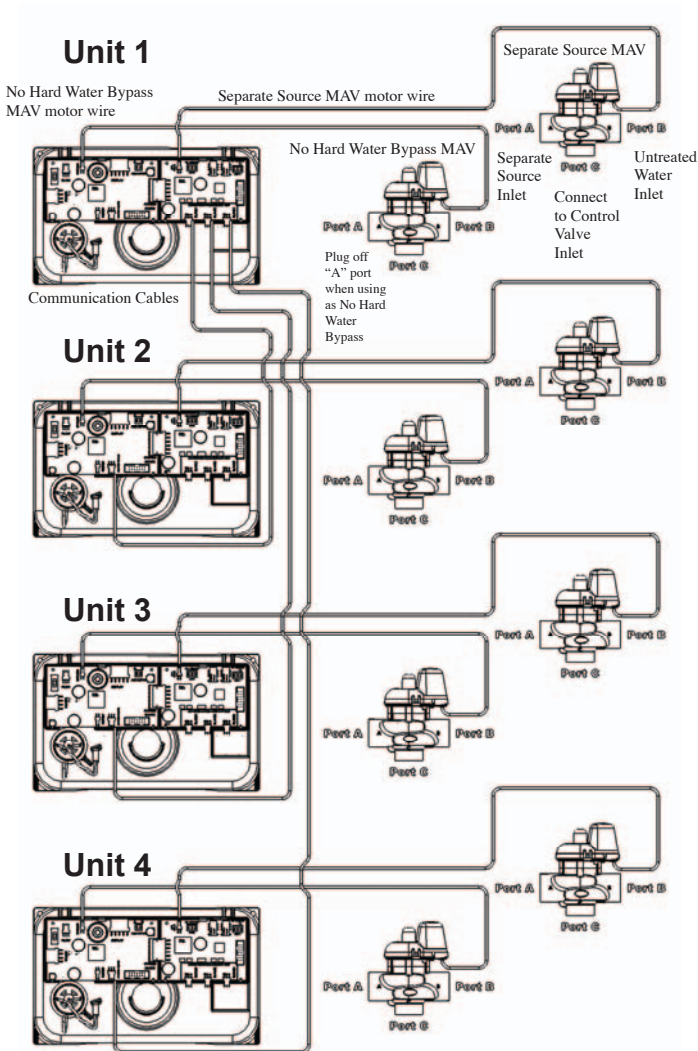

Poppet Style

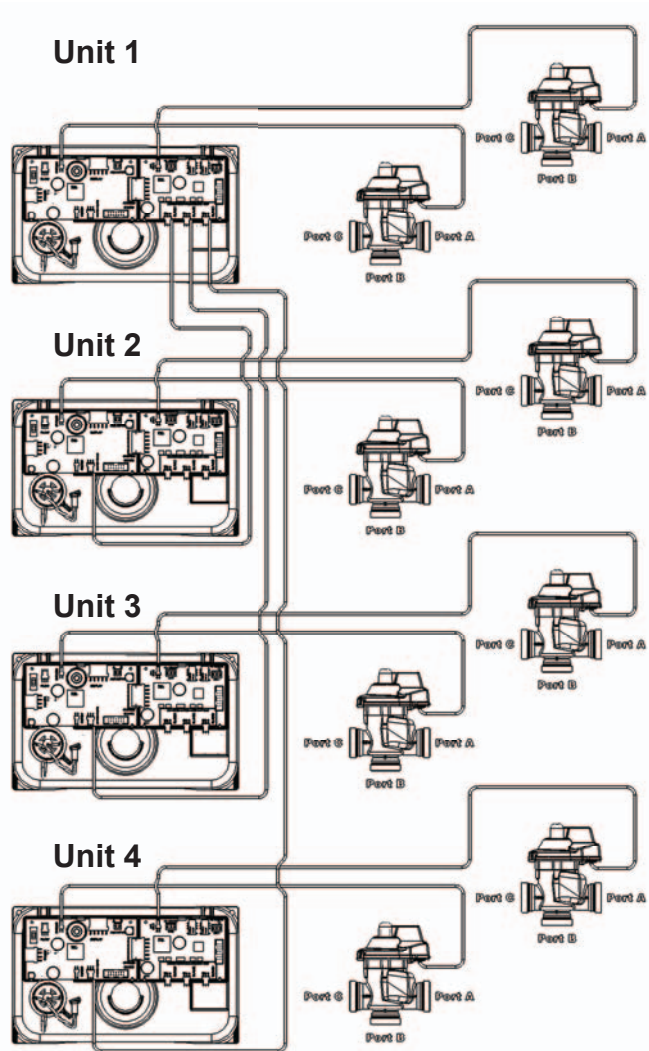

**THIS PAGE LEFT
INTENTIONALLY BLANK.**

WS2H/WS3 Programming Screen Quick Reference

1. Individual screen descriptions and settings are detailed on the following pages.
2. Some screens have been omitted for clarity.

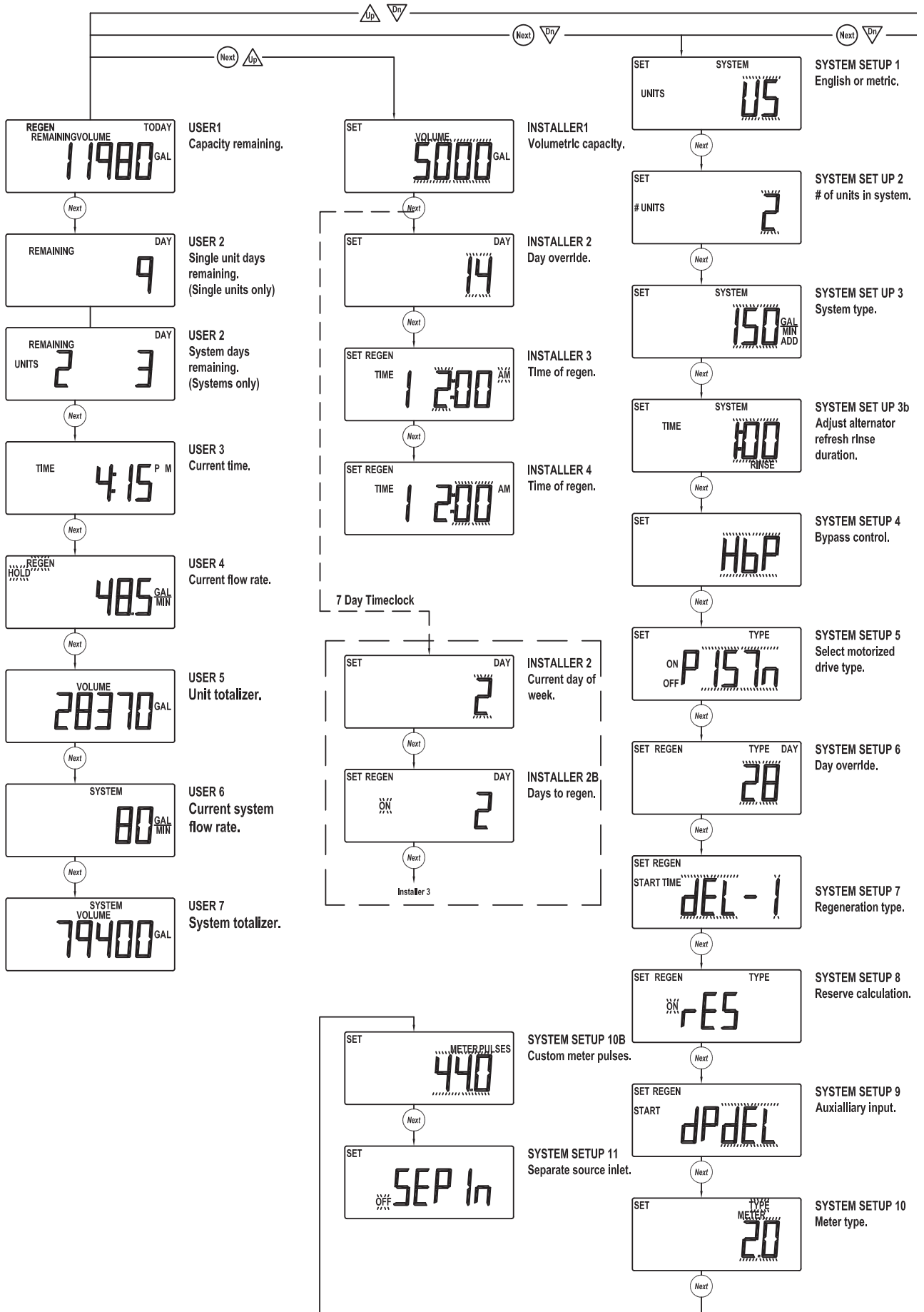

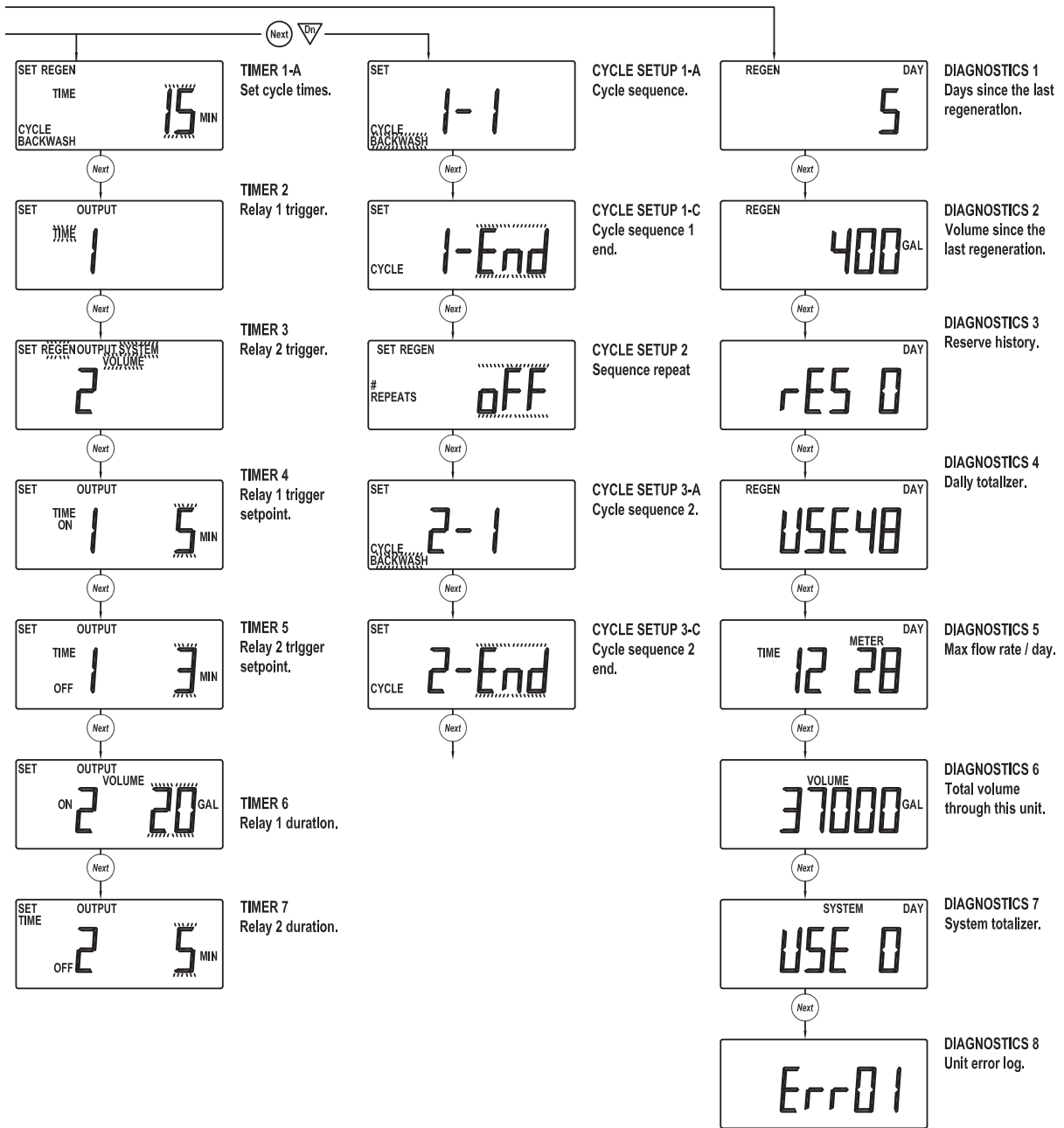

Typical User Screens

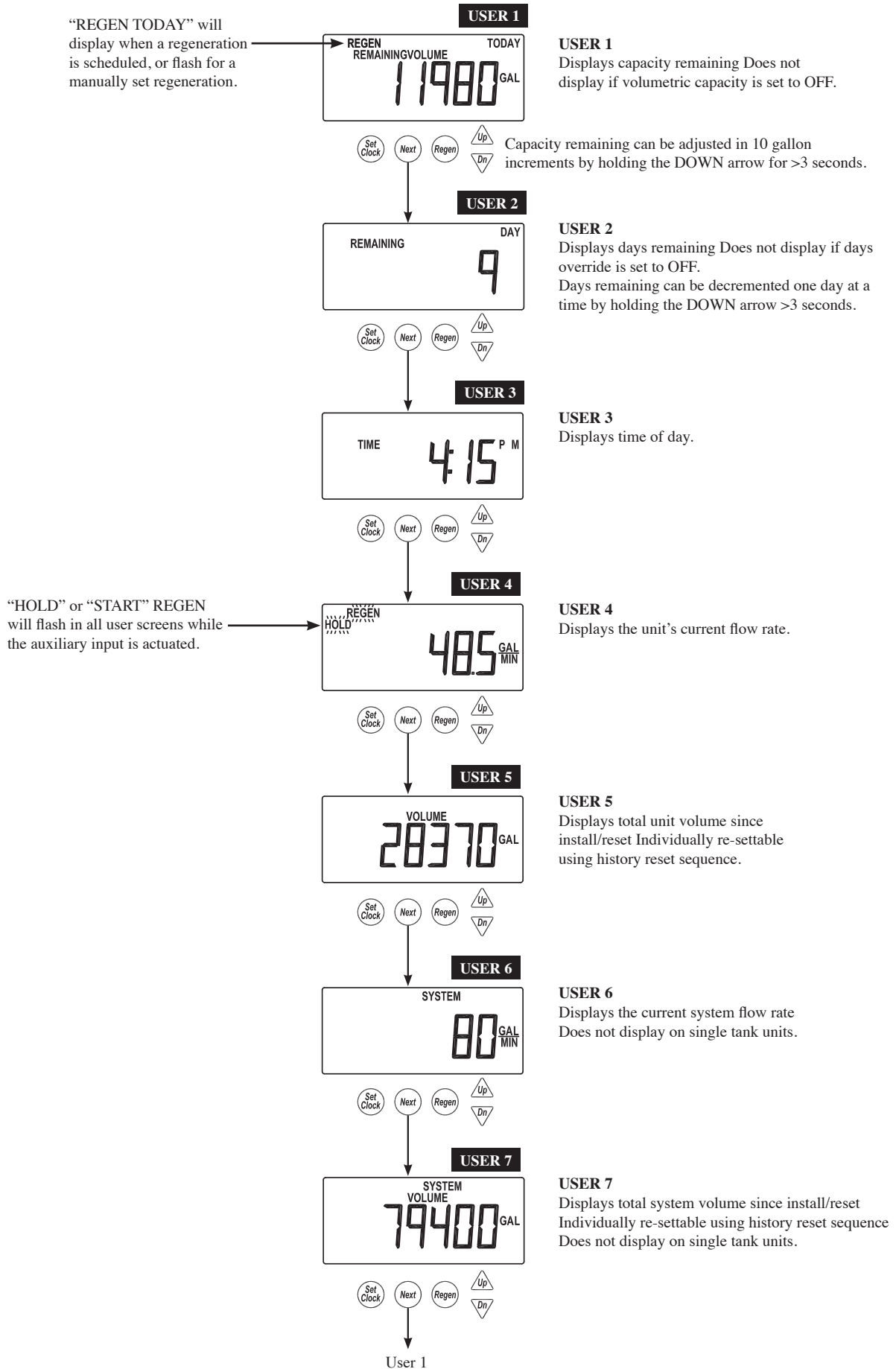

Setting Time of Day

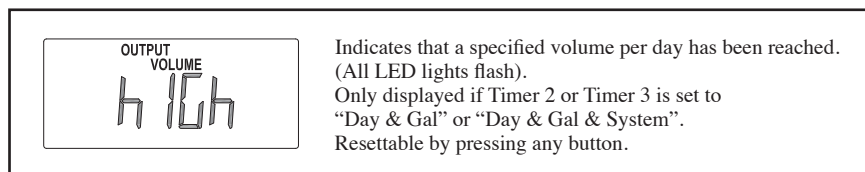
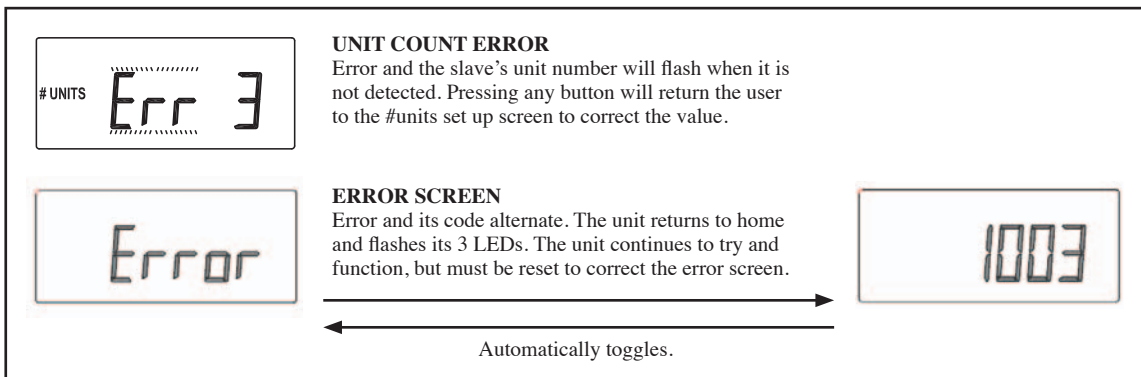
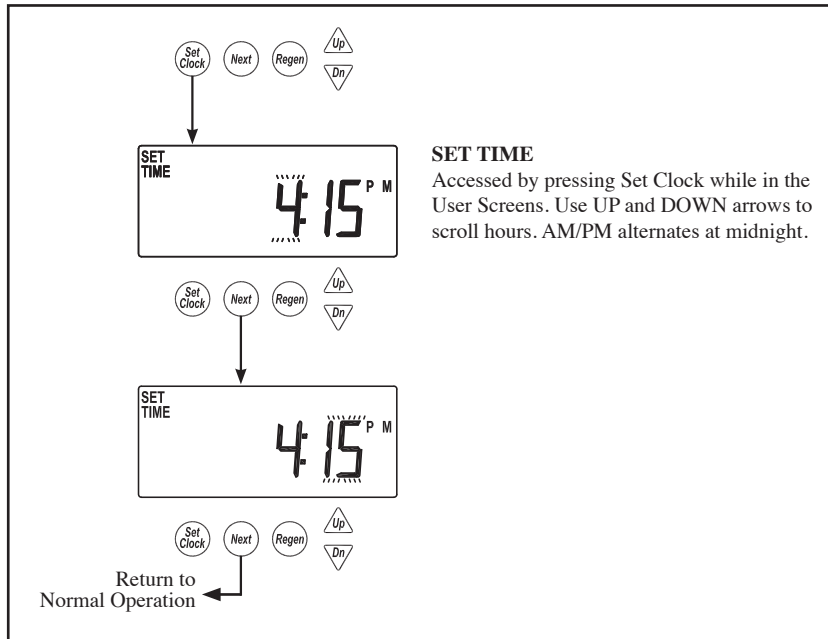

System Setup Screens

Accessed by pressing NEXT and DOWN simultaneously for >3 seconds.

Returns to normal operation after 5 minutes

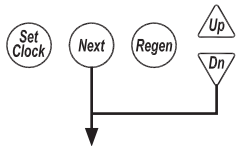

SYSTEM SETUP 1

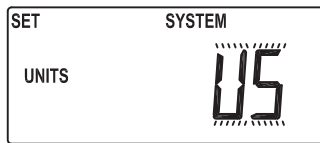

SYSTEM SETUP 1

Select country.

US or SI.

This sets the use of a 12 or 24 hour clock and the display of gallons or liters.

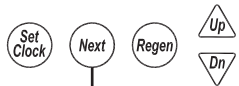

SYSTEM SETUP 2



SYSTEM SETUP 2

Select the total number of units, from 1-4, in a system. This screen will only allow 1 or 2 if a system board is not installed.

Communication cables are required to link multiple units together.

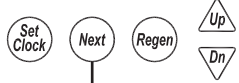

SYSTEM SETUP 3A

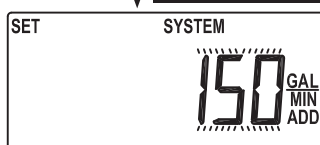

SYSTEM SETUP 3A

The screen will not display if set to 1 unit.

Select unit flow rate unit add point.

1. If set to 0, all units are online unless one is regenerating.
2. If greater than 0, the system acts as a progressive flow system by adding units as flow rate increases.
3. If set to ALT the system acts as an alternator system, keeping one unit off line at all times. An additional screen will appear after ALT is set that will allow the programmer to adjust a pre-service rinse to drain to the stand-by unit before it is called on-line for service.

Progressive Flow Unit		
Units	Range	Increments
US (GAL)	0-499	1
SI (L)	0-1896	4

1. Unit Flow Rate Add Point

- 0: operates the system as a parallel flow system keeping all units online and only allowing one unit to regen at a time. When one unit needs to regenerate it will flag all units to regenerate in series.
- Units in a parallel flow system will determine the need to regenerate based on:
 - Any unit reaching 0 capacity;
 - Delayed units will regenerate at the next available time slot
 - Day over ride
 - 1 day; all units will regen every day as long as it has been >12 hours since any other regenerations
 - Day triggered regens will run in the sequence of times set in the delayed time screens.

2. - 1 – 499: the system acts as a stage by flow keeping one unit online at all times and adding units at this set point.
 - Additional units will be brought online when the adder point is exceeded for >30 seconds or immediately if the flow exceeds 120% of the adder point.
 - Additional units will go offline when system flow reduces to 95% of adder point / unit for > 1 minute.

- Any unit in a demand recall system will determine the need to regenerate based on:
 - Reaching 0 capacity
 - Delayed units will regenerate at the next available time slot
 - Day over ride
 - 1 day; 1 unit will regen / day as long as it has been >12 hours since any other regenerations
 - Day triggered regens will run at the time set in DEL-1
 - Units can not regenerate if flow demands them to remain online
 - On 0 units regen immediately after flow allows them offline
 - Delayed units regen at the next available time slot
 - Day units regen at the next time slot

3. - ALT: operates the system as an alternator, having one unit off line at all times either regenerating or fully regenerated.

- A unit in an alternator system will determine the need to regenerate based on:
 - The current "lead" unit reaching 0 capacity

- Delayed systems will immediately remove depleted units & regenerate at the next available time slot
- "Lead" unit regenerates based on "Lag" units
- (i) The first "lag" unit depleting down to 15% less than its ratio of system capacity
 - 1. 1/3 for a 4 unit; 1/2 for a 3 unit
- (ii) The second "lag" unit depleting down to 15% less than its ratio of system capacity
 - 1. 2/3 for a 4 unit
- Delayed systems will flag "lead" units based on "lag" capacity, but will not alternate with remaining capacity until the next available delayed time.
- Day over ride
- 1 day; 1 unit will regen / day as long as it has been >12 hours since any other regenerations
- Day triggered regens will run at the time set in DEL-1

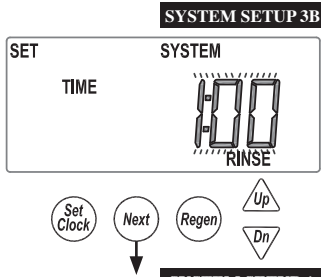

SYSTEM SETUP 3B

Set Pre-Service Rinse time for units coming online. Adjustable from OFF - 20 minutes in 30 second increments. This screen only displays for alternator systems. Default: 1:00

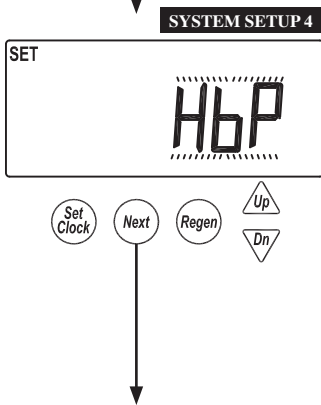

SYSTEM SETUP 4

Hardwater Bypass

- Single units have a selection of Hbp, noHbP or Relay
- 2 unit alternators have a selection of noHbP, Relay or ALT-A
- All other systems have a choice of noHbP or Relay

1. If set to HbP: Units will have hard water bypass while in a regeneration
2. If set to noHbP: Single units or multiple tank systems require a motorized bypass valve or motorized alternating valve to be connected to the bypass connector on the main valve PC board. This setting will force an initialization of the motorized drive to determine its current position.
3. If set to Relay: Units will have other types of external valves controlling the water supply. If relay 1 & 2 are both set to STbY, relay 1 will close to remove a unit from service & open to add a unit. Relay 2 will actuate 15 seconds after relay 1 and will operate in the opposite sequence as relay 1. To come back online is the opposite; relay 2 actuates 1st & relay 1 actuates after 15 seconds relay 2.
4. If set to ALT-A: requires a Motorized Alternating Valve (MAV) to be connected to the two pin connection labeled "BYPASS" on Unit 2's PC Board. A communication cable is required to connect ALT-A and Unit 2 together.
 - Any setting requiring a motorized bypass valve or motorized alternating valve will cause the drive to initialize to determine its current position.
 - Units going through a reset or initial startup, the bypass or motorized alternating valve may torque early which would cause the unit to run the drive in the opposite direction, then re-home
 - Pressing any button while in the Error / Hbp screen will kick the user into hbp setting screen and allow correction. Upon exiting the unit will try to re-initialize the motorized drive.

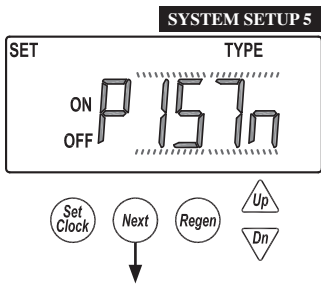

SYSTEM SETUP 5

Select between piston or poppet style bypass drive. Default - PISTn

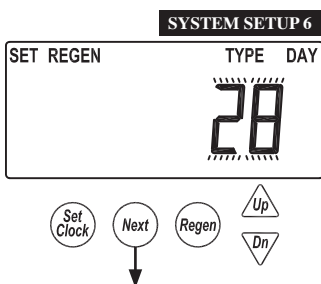
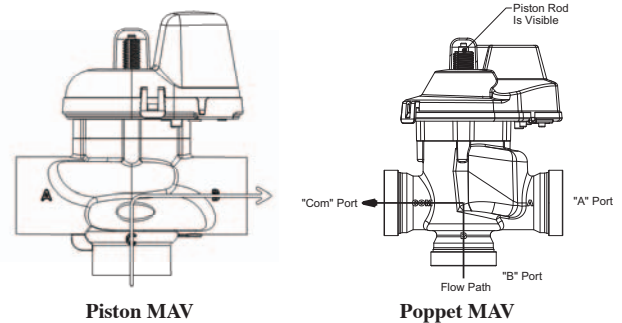

SYSTEM SETUP 6

Select day control type.

Time clock 1-28 day; Time clock 7 day; or OFF.

When volumetric capacity is set, volume regeneration can be combined with time clock control. OFF will not be an option if volumetric capacity is OFF.

System Setup Screens (continued)

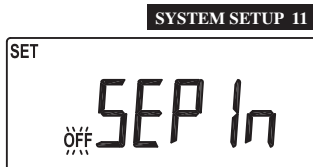
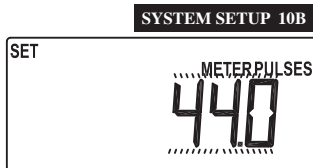
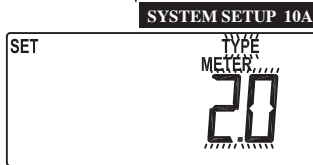
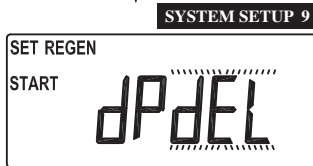
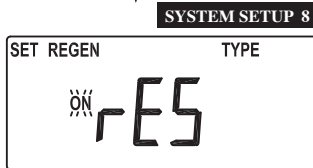
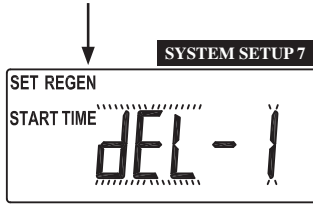

Return To Normal Operation

SYSTEM SETUP 7

Select regeneration type.
Delayed (dEL-1)
Delayed, 2 regenerations per day (dEL-2)
Delayed, 3 regenerations per day (dEL-3)
Delayed, 4 regenerations per day (dEL-4)
On 0

Delayed regeneration times are set in installer screens.
Delayed with multiple regenerations allowed per day would be used either to reduce the reserve volume, or to accommodate a small system relative to the treatment demand.

SYSTEM SETUP 8

Select reserve calculation ON or OFF.
OFF will schedule a regen when the volumetric capacity reaches 0. This screen will not display for “on0” units or systems.

SYSTEM SETUP 9

Set auxiliary initiated regen.
START TIME REGEN: regeneration will start immediately after 2 cumulative minutes of switch closure.
START TIME REGEN dEL: regeneration will start at the delayed time after 2 cumulative minutes of switch closure.
START REGEN: regeneration will start immediately upon switch closure.
START REGEN dEL: regeneration will start at the delayed time upon switch closure.
HOLD REGEN: regeneration will not be allowed as long as there is switch closure.

SYSTEM SETUP 10A

Select meter type, meter pulses or system pulses.
2.0 meter (type)
3.0 meter (type)
Meter Pulses (used on single units for non-Clack meters)
System Pulses (used on two unit systems that share one meter)

SYSTEM SETUP 10B

Select meter type pulses.
Screen does not show if Pulses or System Pulses is not selected in the previous screen.

SYSTEM SETUP 11

Separate source inlet. This screen will not display if a system board is not installed.
One System Board is required and 2 Motorized Alternating Valves (MAV) are needed. One will be used on the inlet water supply to alternate between the raw water supply and the separate source regeneration water supply. The other MAV will be used on the outlet to create No Hard Water Bypass. Refer to wiring diagrams for proper connections.

	Pulses / Unit Flow	
Units	Range	Increment
US (Pulse/Gal)	0.5 - 80.0 90.0 - 500.0	0.5 2.0
SI (Pulse/L)	0.1 - 20.0 20.0 - 150.0	0.1 0.5

Cycle Setup Screens

Returns to normal operation after 5 minutes.

Accessed by pressing NEXT and DOWN simultaneously for >3 seconds, then by pressing NEXT and DOWN simultaneously again for >3 seconds, then by pressing NEXT and DOWN simultaneously for >3 seconds a third time.

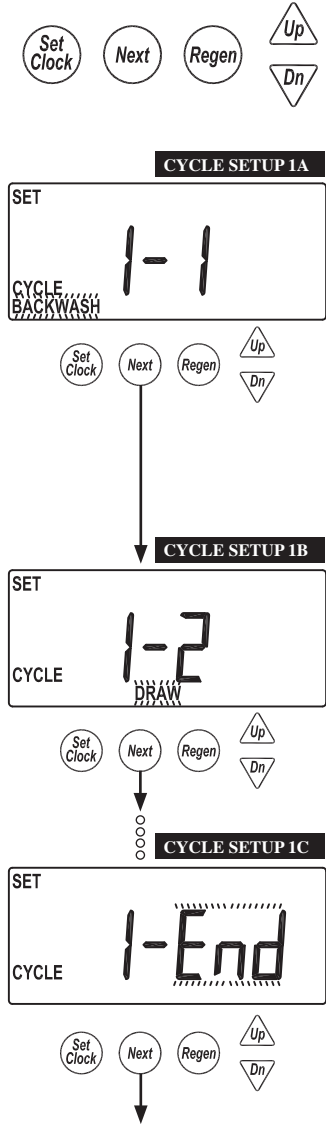

CYCLE SETUP 1A
Select first cycle.

CYCLE SETUP 1B
Select second cycle.

CYCLE SETUP 1C
After cycles are configured, an END is added.
(9 cycles maximum.)

Available Cycles	
Backwash	
Draw	
Slow Rinse	Separate cycle from Draw
2nd Backwash	
Rinse (fast)	
Fill	
End	
Hold	Piston in Service position

Cycle #	Cycle Default
1	Backwash
2	Draw
3	2nd Backwash
4	Rinse
5	Fill
6	End

Cycle Setup Screens (continued)

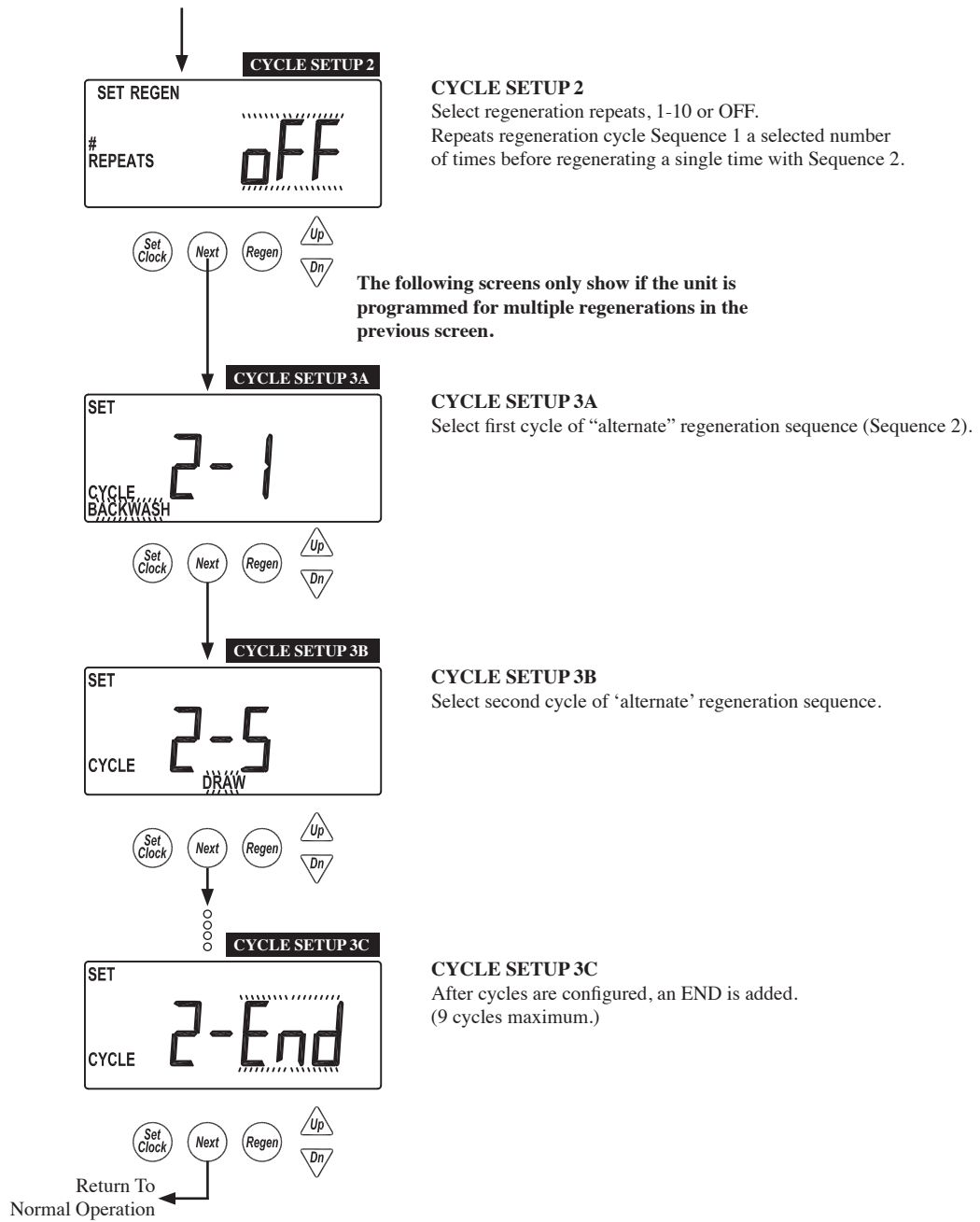

Timer Screens

Returns to normal operation after 5 minutes.

Accessed by pressing NEXT and DOWN simultaneously for >3 seconds, then by pressing NEXT and DOWN simultaneously again for >3 seconds.

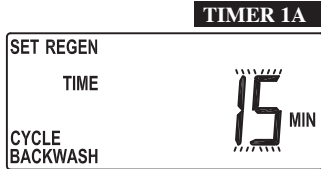

TIMER 1A
Select time of cycle 1.



A NEXT & DN reset from this screen unlocks the setup screens.

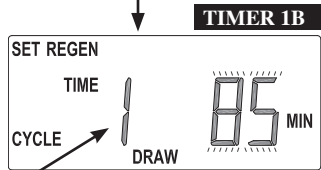

TIMER 1B
Select time of cycle 2.

"1" is displayed if set for more than one sequence



The following screens only show if the unit is programmed for multiple regenerations in the Cycle Setup 2 screen.

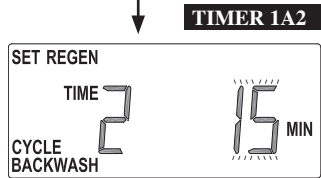

TIMER 1A2
Select time of alternate regen, cycle 1.

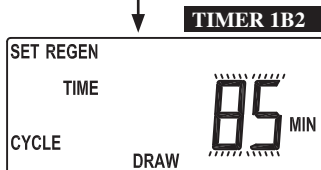

TIMER 1B2
Select time of alternate regen, cycle 2.



Cycle	Units	Range	Increments
Backwash	Minutes	1-30 30-95	1 5
Draw	Minutes	1-30 30-100 100-180	1 5 10
Slow Rinse	Minutes	1-30 30-95	1 5
Rinse	Minutes	1-30 30-95	1 5
Fill	Minutes	0.1-10.0 10.0-30.0 30.0-99.0	0.1 0.2 1.0
Hold	Minutes	1-30 30-100 100-480	0.1 2.0 10.0

Timer Screens (continued)

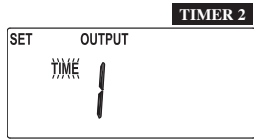

TIMER 2

Set output for Relay 1.

These settings will only be allowed with the system board installed.

Time: Relay is activated after specified time from the start of regen and is left on for a specified time.

Cycle: Relay is activated after the start of a specified cycle and is left on for a specified time.

Volume: Relay is activated, during service flow only, every specified number of volume units and is left on for a specified time.

Volume & Regen: Relay is activated every specified number of volume units, and is left on for a specified time.

Volume & System: This option, only available on master units, would calculate relay actuation based on system flow, monitoring all units current flow rate.

Day & Gal: Relay actuates at specified daily volume & "Usage High" is displayed on the screen. Pressing any button resets relay and returns unit to user screens.

Day & Gal & System: Only available on the master unit. Relay actuates after a specified daily volume is used by the system & "Usage High" flashes on the screen. Pressing any button resets relay and returns unit to user Screens.

STbY: Relay would be used to control external valving, closing for unit regeneration, or when it would be offline in system operation.

REGEN: Relay is activated when the unit is in regen.

Err: Relay is activated when the unit is in any error mode.

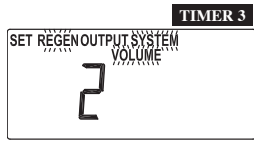

TIMER 3

Set output for Relay 2.

These settings will only be allowed with the system board installed.

Time: Relay is activated after specified time from the start of regen and is left on for a specified time.

Cycle: Relay is activated after the start of a specified cycle and is left on for a specified time.

Volume: Relay is activated, during service flow only, every specified number of volume units and is left on for a specified time.

Volume & Regen: Relay is activated every specified number of volume units, and is left on for a specified time.

Volume & System: This option, only available on master units, would calculate relay actuation based on system flow, monitoring all units current flow rate.

Day & Gal: Relay actuates at specified daily volume & "Usage High" is displayed on the screen. Pressing any button resets relay and returns unit to user screens.

Day & Gal & System: Only available on the master unit. Relay actuates after a specified daily volume is used by the system & "Usage High" flashes on the screen. Pressing any button resets relay and returns unit to user Screens.

STbY: Relay would be used to control external valving, closing for unit regeneration, or when it would be offline in system operation.

REGEN: Relay is activated when the unit is in regen.

Err: Relay is activated when the unit is in any error mode.

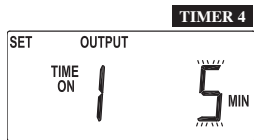

TIMER 4

Select Relay 1 output "ON" trigger set point, per units previously selected.

This screen will not display if the unit does not have a system board, or if STbY was selected as the trigger.

Time: Time after the start of a regen before relay is activated.

Cycle: Select a cycle which will actuate output 1.

Volume: Volume of water interval during service between relay actuations.

Timer 4 and 6 screens will not display if display if STbY, REGEN or Err are selected in TIMER 2 and TIMER 3.

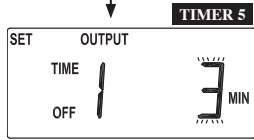

TIMER 5

Set duration of how long Relay 1 output will be on before turning "OFF." This screen will not display if the unit does not have a system board.

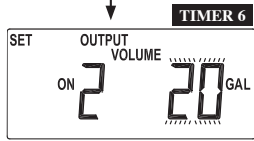

TIMER 6

Select Relay 2 output "ON", per units previously selected.

This screen will not display if the unit does not have a system board, or if STbY was selected as the trigger

Time: Time after the start of a regen before relay is actuated.

Cycle: Select a cycle which will actuate output 1.

Volume: Volume of water interval during service between relay actuations.

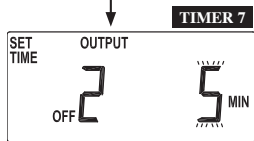

TIMER 7

Set duration of how long Relay 2 output will be on before turning "OFF."

This screen will not display if the unit does not have a system board.

Return To Normal Operation.

Relay Trigger Settings				
Trigger	Units	Range	Increment	Default
Time	Minutes	0 - 240	1	10
Cycle				Slow Rinse
Volume	Gallons	1 - 200 200 - 1000 1000 - 10000	1 5 10	20
Volume	Liters	5 - 750 750 - 4000 4000 - 38000	5 20 40	75
Relay Duration Settings				
Trigger	Units	Range	Increment	Default
Time	Minutes	:01 - 2:00 2:00 - 20:00 20 - 240	:01 :05 1	3:00

Installer Setup Screens

Accessed by pressing NEXT and UP simultaneously for >3 seconds.

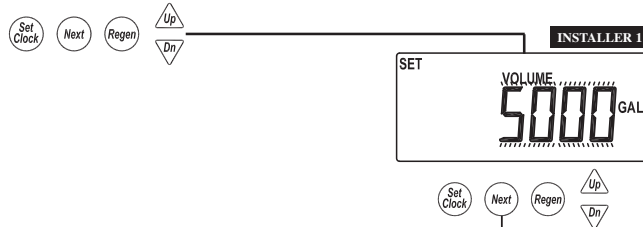

Set current day and regen days when set as a 7 day time clock or hybrid in System Setup 1.

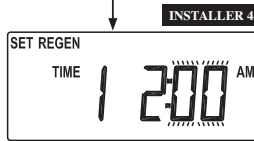
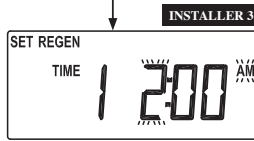
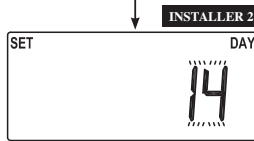

Return To Normal Operation.

7 Day Option

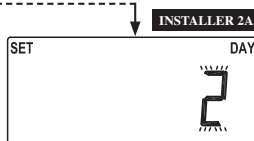

Installer 3

Returns to normal operation after 5 minutes.

INSTALLER 1

Set volumetric capacity or OFF. OFF will not be an option if the day control is set to OFF.

X1000 Indicator Illuminates At 10,000 Gallons

Units	Range	Increments
US (GAL)	10-10,000	10
	10,000-100.00 x 1000	100
	100.00-999.00 x 1000	1000
SI (L)	50-50,000	50
	50,000-50.00 x 1000	50
	500.00-5000.0 x 1000	5000

INSTALLER 2

Set day override. 1-28 days between regenerations, or if set to 7 day time clock, see 7 day setup below. OFF will only be displayed if "OFF" is selected in System Setup Screen 6.

INSTALLER 3

Select time of regen. Use up and down arrows to scroll hours. AM/PM alternates at midnight. "on0" will be displayed on units with no time dependent regen control. ("1" only shows if set for multiple regens.)

INSTALLER 4

Select time of regen. Use up and down arrows to scroll minutes.

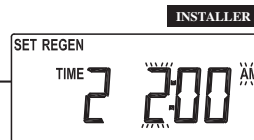

INSTALLER 5

Select time of 2nd regen (if configured as a multiple regenerating unit.)

INSTALLER 2A

7 day time clock option. Set current day of the week:

- 1 = Sunday
- 2 = Monday
- 3 = Tuesday
- 4 = Wednesday
- 5 = Thursday
- 6 = Friday
- 7 = Saturday

INSTALLER 2B

Scroll through days 1-7 using the UP and DOWN arrows. Pressing the Set Clock will toggle regen ON or OFF for that day. (i.e., regen on Monday.)

INSTALLER 2C

(i.e., no regeneration on Saturday.)

Diagnostic Screens

Accessed by pressing UP and DOWN simultaneously for >3 seconds.

Returns to normal operation after 5 minutes.

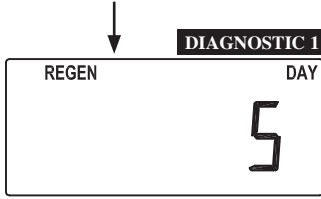

DIAGNOSTICS 1
Days since the last regeneration.

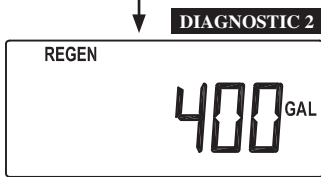
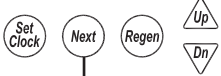

DIAGNOSTICS 2
Gallons or Liters x1000 since the last regeneration.

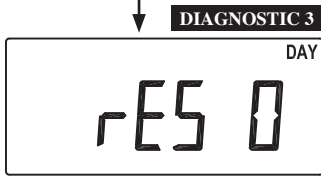
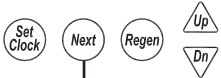

DIAGNOSTICS 3
Reserve history. This screen only appears if valve is set to calculate Reserve in System Setup 8. Use arrows to select a day.
0 = Today
1 = Yesterday
6 = 6 days ago (max.)

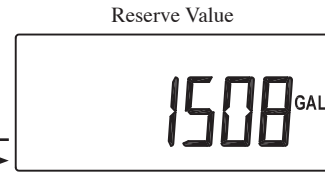

Automatically Toggles

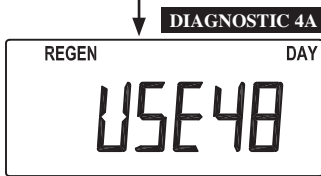
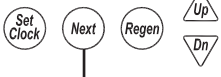

DIAGNOSTICS 4A
History of volume used. Use UP and DOWN arrows to select a day.
0 = Today
1 = Yesterday
63 = 63 days ago (max.)

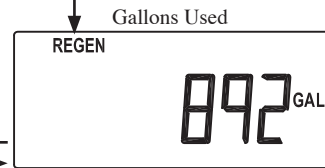

Automatically Toggles

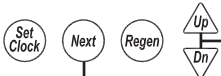

Simultaneously press UP and DOWN.

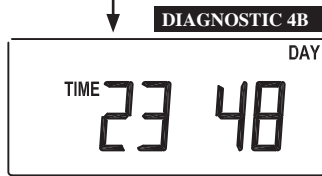

DIAGNOSTICS 4B
Hourly history of volume use. Use the UP and DOWN arrow to select the hours of the day from screen 4.

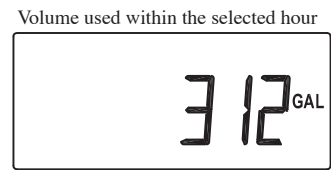

Automatically Toggles

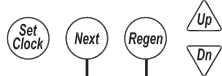

Returns user back to USE Day 0 in Diagnostic 4 screen.

All Diagnostic History screens are resettable with the History Reset sequence while in the Diagnostics 1 screen. Holding the Set Clock and Regen buttons for > 3 seconds initiates a totalizer or history reset.

Diagnostic Screens (continued)

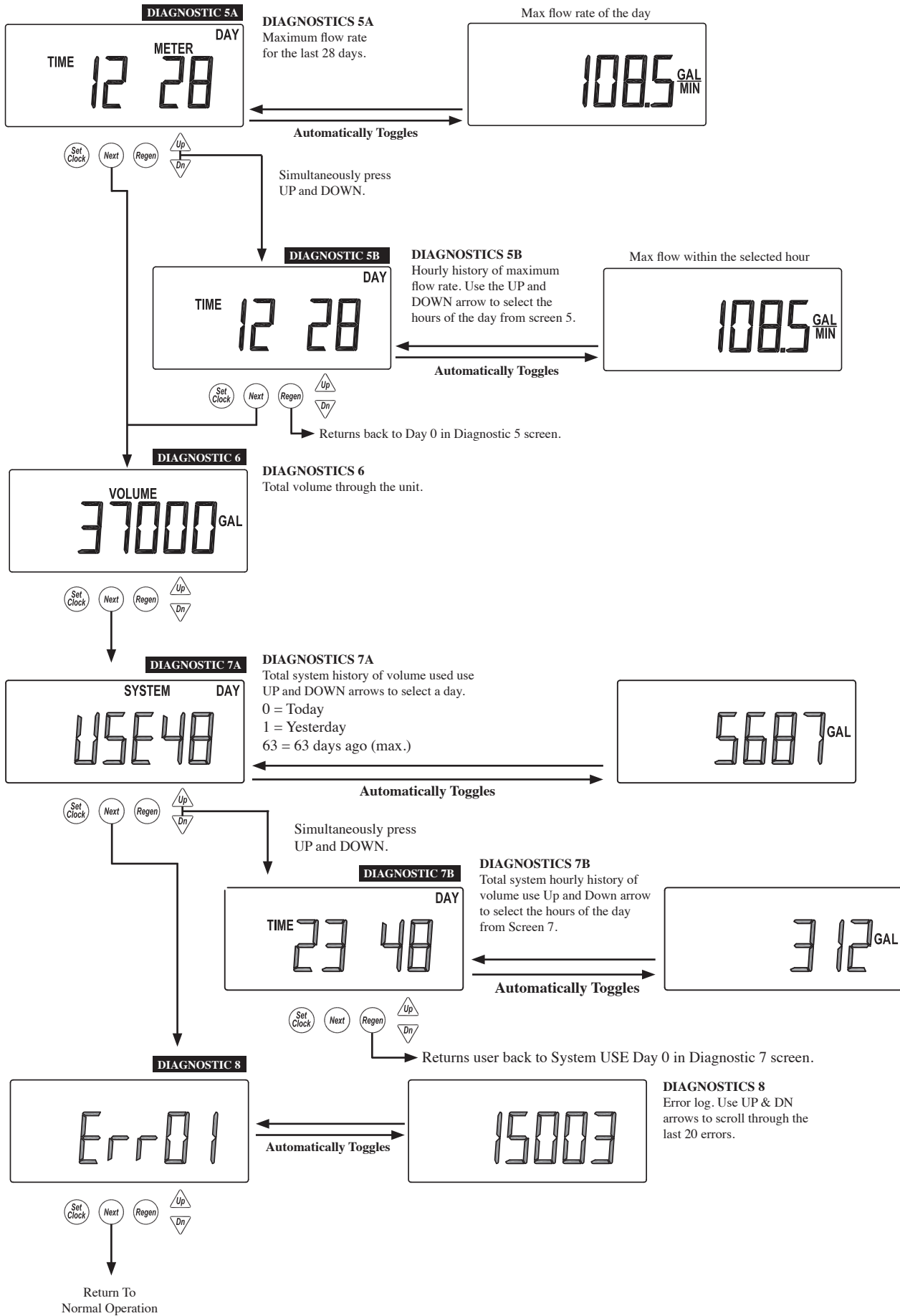

Valve History

Returns to normal operation after 5 minutes.

Non-Resettable

Accessed by pressing UP and DOWN simultaneously for >3 seconds, then by pressing UP and DOWN simultaneously again for >3 seconds.

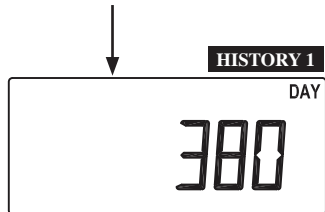

HISTORY 1
Total days since startup.
Time only accumulates while the unit is plugged in.



HISTORY 2
Total regenerations since startup.



HISTORY 3
Total volume since startup.



HISTORY 4
Main board firmware revision.

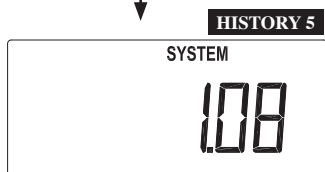
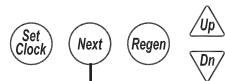

HISTORY 5
System board firmware revision. Will display -nA- if no system board is detected.



Return To Normal Operation

Revision History:

6/11/2010

PAGE 4:

Table 1

Output Voltage 20V or 24V AC see Table 2

PAGE 5:

Added Table 2

PAGE 6:

Added:



Medium Reset
From User 1 Screen - Volume Remaining
Press and hold the Set Clock and Regen buttons for 10 seconds to reset valve
to factory default programming. History and Diagnostics are not changed.

See Table 2 Software and Power Supply Compatibility.

b. Pin 1 = AC from power supply (White) Pin 2 = Jumper to Pin 3
Pin 3 = Jumper to Pin 2 Pin 4 = AV from power supply (Black)

PAGE 7:

Layout drawing revised.

PAGE 8:

Wiring drawing revised

PAGE 9:

System board drawing revised.

PAGE 10-18:

Revised drawings for Poppet MAV setups.

5/20/2010

PAGE 12:

change four pin to three pin

PAGE 13:

change four pin to three pin

PAGE 14:

• The communication cable needs to be connected to Unit 1's three pin connection labeled "MASTER/SLAVE" and Unit 2's three pin connection labeled "MASTER/SLAVE"

PAGE 15:

change four pin to three pin

PAGE 16:

change four pin to three pin

PAGE 17:

change four pin to three pin

PAGE 18:

change four pin to three pin